

ERRATA

There were some errors in the instruction manual. We apologize for this and correct them as follows.

	INCORRECT	CORRECT
Page 10	<p style="text-align: center;">Turning the Power On and Standby Mode</p> <ul style="list-style-type: none"> If the power cord is unplugged from the wall socket for more than <u>an hour</u>, the internal clock, program, etc. of the main unit may require resetting. When this occurs, please set the clock (and timer functions) again. 	<ul style="list-style-type: none"> If the power cord is unplugged from the wall socket for more than <u>a few seconds</u>, the internal clock, program, etc. of the main unit may require resetting. When this occurs, please set the clock (and timer functions) again.
Page 17	<p style="text-align: center;">Programming Playback Using Main Unit Controls</p> <p>1 Load CDs into the trays of the 3-CD changer.</p> <ul style="list-style-type: none"> Only tracks on the CDs loaded in the 3-CD changer can be registered into the program (i.e., tracks on a CD loaded in the CDR cannot be selected for playback). “CD READ DISC” will be shown in the information display as the unit reads the information from each disc. 	<p>1 Load CDs into the trays of the 3-CD changer.</p> <ul style="list-style-type: none"> Only tracks on the CDs loaded in the 3-CD changer can be registered into the program (i.e., tracks on a CD loaded in the CDR cannot be selected for playback). “CD READ DISC” will be shown in the information display as the unit reads the information from each disc. <p>Note</p> <ul style="list-style-type: none"> <u>To close a tray, press the ▲ button for the tray number that is open. If you press the ▲ button for a tray number other than that for the tray that is open, the program may not be played correctly.</u>
Page 18	<p style="text-align: center;">Programming Playback Using the Remote Control</p> <p>1 Load CDs into the trays of the 3-CD changer.</p> <ul style="list-style-type: none"> Only tracks on the CDs loaded in the 3-CD changer can be registered into the program (i.e., tracks on a CD loaded in the CDR cannot be selected for playback). “CD READ DISC” will be shown in the information display as the unit reads the information from each disc. 	<p>1 Load CDs into the trays of the 3-CD changer.</p> <ul style="list-style-type: none"> Only tracks on the CDs loaded in the 3-CD changer can be registered into the program (i.e., tracks on a CD loaded in the CDR cannot be selected for playback). “CD READ DISC” will be shown in the information display as the unit reads the information from each disc. <p>Note</p> <ul style="list-style-type: none"> <u>To close a tray, press the ▲ button for the tray number that is open. If you press the ▲ button for a tray number other than that for the tray that is open, the program may not be played correctly.</u>
Page 27	<p style="text-align: center;">Program Edit Recording</p> <p>1 Load CDs in the 3-CD changer</p>	<p>1 Load CDs in the 3-CD changer</p> <p>Note</p> <ul style="list-style-type: none"> <u>To close a tray, press the ▲ button for the tray number that is open. If you press the ▲ button for a tray number other than that for the tray that is open, the program may not be played correctly.</u>

ERRATA

There were some errors in the instruction manual. We apologize for this and correct them as follows.

	INCORRECT	CORRECT
Page 29	<p style="text-align: center;">Setting the Unit for High-speed Recording</p> <p>4 Turn the MULTI JOG control or press the ◀/▶ (menu) button on the remote control to select “HIGH” or “1x”.</p> <ul style="list-style-type: none"> • If “HIGH” is selected, “HIGH” flashes in the display window. • Press the CANCEL button (main unit/remote control) to cancel the procedure and return to the normal display. 	<p>4 Turn the MULTI JOG control or press the ◀/▶ (menu) button on the remote control to select “HIGH” or “1x”.</p> <ul style="list-style-type: none"> • If “HIGH” is selected, “HIGH” flashes in the display window. • Press the CANCEL button (main unit/remote control) to cancel the procedure and return to the normal display. <p><u>5 Press the SET button.</u></p>
Page 30	<p style="text-align: center;">Setting the Auto Track Spacing Function</p> <p>4 Turn the MULTI JOG control or press the ◀/▶ (menu) button on the remote control and choose the setting “TR SPACE ON” or “TR SPACE OFF”.</p> <ul style="list-style-type: none"> • Press the CANCEL button (main unit/remote control) to cancel the procedure and return to the normal display. 	<p>4 Turn the MULTI JOG control or press the ◀/▶ (menu) button on the remote control and choose the setting “TR SPACE ON” or “TR SPACE OFF”.</p> <ul style="list-style-type: none"> • Press the CANCEL button (main unit/remote control) to cancel the procedure and return to the normal display. <p><u>5 Press the SET button.</u></p>
Page 38	<p style="text-align: center;">Setting the Present Time</p> <p>Set the timer immediately after turning on the power to the main unit for the first time. Additionally, should there be a power black-out that lasts for longer than <u>one hour</u>, or if the AC power cord of the unit is unplugged from the wall socket for longer than <u>one hour</u>, please check to see if the clock needs to be reset again before using any other operation.</p>	<p>Set the timer immediately after turning on the power to the main unit for the first time. Additionally, should there be a power black-out that lasts for longer than <u>a few seconds</u>, or if the AC power cord of the unit is unplugged from the wall socket for longer than <u>a few seconds</u>, please check to see if the clock needs to be reset again before using any other operation.</p>
Page 40	<p style="text-align: center;">Timer Play (wake-up play)</p> <p>5 Press the SET button.</p> <ul style="list-style-type: none"> • “DAILY TIMER” is shown in the information window. <p>To set DAILY TIMER Proceed to step <u>5</u>.</p> <p>To set ONCE TIMER Press the MENU button and display “ONCE TIMER”, and then proceed to step <u>5</u>.</p>	<p>5 Press the SET button.</p> <ul style="list-style-type: none"> • “DAILY TIMER” is shown in the information window. <p>To set DAILY TIMER Proceed to step <u>6</u>.</p> <p>To set ONCE TIMER Press the MENU button and display “ONCE TIMER”, and then proceed to step <u>6</u>.</p>

JVC



CD/CDR MULTIPLE COMPACT DISC RECORDER COMBINE ENREGISTREUR CHANGEUR DE CD/CDR

XL-R5010BK

K2
INTERFACE

COMPU LINK
Component

COMPACT
disc
DIGITAL AUDIO
Recordable
ReWritable

COMPACT
disc
DIGITAL AUDIO

3-CD
PLAY & EXCHANGE

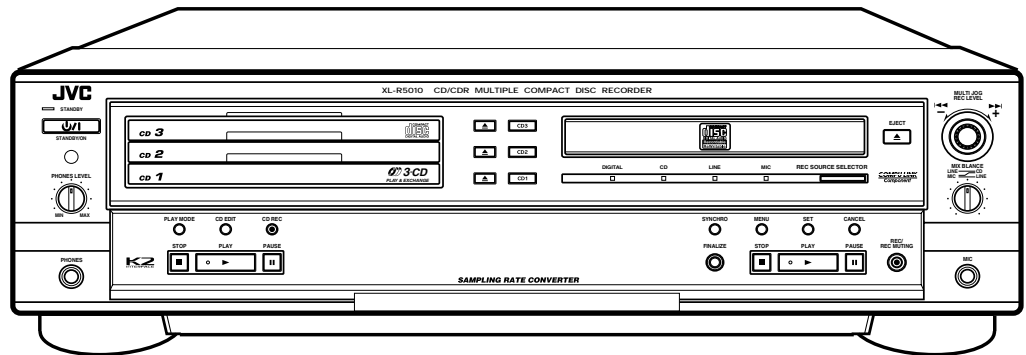
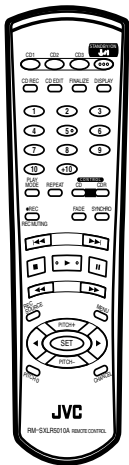

INSTRUCTIONS MANUEL D'INSTRUCTIONS

For Customer Use:

Enter below the Model No. and Serial No. which are located on the rear, bottom or side of the cabinet. Retain this information for future reference.

Model No. _____

Serial No. _____

LET0181-002A

[C]

Warnings, Cautions and Others / Mises en garde, précautions et indications diverses

(For U.S.A)

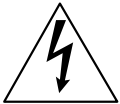
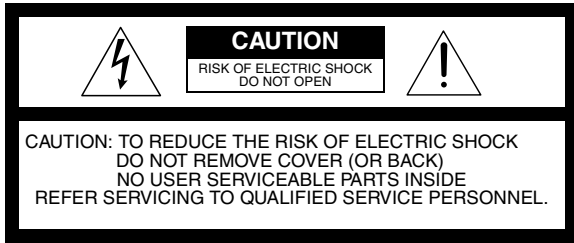

The lightning flash with arrowhead symbol, within an equilateral triangle is intended to alert the user to the presence of uninsulated “dangerous voltage” within the product’s enclosure that may be of sufficient magnitude to constitute a risk of electric shock to persons.



The exclamation point within an equilateral triangle is intended to alert the user to the presence of important operating and maintenance (servicing) instructions in the literature accompanying the appliance.

WARNING: TO REDUCE THE RISK OF FIRE OR ELECTRIC SHOCK, DO NOT EXPOSE THIS APPLIANCE TO RAIN OR MOISTURE.

INFORMATION

This equipment has been tested and found to comply with the limits for a Class B digital device, pursuant to Part 15 of the FCC Rules. These limits are designed to provide reasonable protection against harmful interference in a residential installation. This equipment generates, uses, and can radiate radio frequency energy and, if not installed and used in accordance with the instructions, may cause harmful interference to radio communications. However, there is no guarantee that interference will not occur in a particular installation. If this equipment does cause harmful interference to radio or television reception, which can be determined by turning the equipment off and on, the user is encouraged to try to correct the interference by one or more of the following measures:

- Reorient or relocate the receiving antenna.
- Increase the separation between the equipment and receiver.
- Connect the equipment into an outlet on a circuit different from that to which the receiver is connected.
- Consult the dealer or an experienced radio/TV technician for help.

For Canada/pour le Canada

CAUTION: TO PREVENT ELECTRIC SHOCK, MATCH WIDE BLADE OF PLUG TO WIDE SLOT, FULLY INSERT.

PRECAUTION: POUR EVITER LES CHOCS ELECTRIQUES, INTRODUIRE LA LAME LA PLUS LARGE DE LA FICHE DANS LA BORNE CORRESPONDANTE DE LA PRISE ET POUSSER JUSQU'AU FOND.

For Canada/pour le Canada

THIS DIGITAL APPARATUS DOES NOT EXCEED THE CLASS B LIMITS FOR RADIO NOISE EMISSIONS FROM DIGITAL APPARATUS AS SET OUT IN THE INTERFERENCE-CAUSING EQUIPMENT STANDARD ENTITLED "DIGITAL APPARATUS," ICES-003 OF THE DEPARTMENT OF COMMUNICATIONS.

CET APPAREIL NUMERIQUE RESPECTE LES LIMITES DE BRUITS RADIOELECTRIQUES APPLICABLES AUX APPAREILS NUMERIQUES DE CLASSE B PRESCRITES DANS LA NORME SUR LE MATERIEL BROUILLEUR: "APPAREILS NUMERIQUES", NMB-003 EDICTEE PAR LE MINISTRE DES COMMUNICATIONS.

1. CLASS 1 LASER PRODUCT
2. **DANGER:** Invisible laser radiation when open and interlock failed or defeated. Avoid direct exposure to beam.
3. **CAUTION:** Do not open the top cover. There are no user serviceable parts inside the unit; leave all servicing to qualified service personnel.

1. PRODUIT LASER CLASSE 1
2. **ATTENTION:** Radiation laser invisible quand l'appareil est ouvert ou que le verrouillage est en panne ou désactivé. Eviter une exposition directe au rayon.
3. **ATTENTION:** Ne pas ouvrir le couvercle du dessus. Il n'y a aucune pièce utilisable à l'intérieur. Laisser à un personnel qualifié le soin de réparer votre appareil.

CAUTION

To reduce the risk of electrical shocks, fire, etc.:

1. Do not remove screws, covers or cabinet.
2. Do not expose this appliance to rain or moisture.

ATTENTION

Afin d'éviter tout risque d'électrocution, d'incendie, etc.:

1. Ne pas enlever les vis ni les panneaux et ne pas ouvrir le coffret de l'appareil.
2. Ne pas exposer l'appareil à la pluie ni à l'humidité.

Caution — STANDBY/ON \odot /I BUTTON!

Disconnect the mains plug to shut the power off completely. The STANDBY/ON \odot /I button in any position does not disconnect the mains line. The power can be remote controlled.

Attention — Commutateur STANDBY/ON \odot /I!

Déconnecter la fiche de secteur pour couper complètement le courant. Le commutateur STANDBY/ON \odot /I ne coupe jamais complètement la ligne de secteur, quelle que soit sa position. Le courant peut être télécommandé.

Caution: Proper Ventilation

To avoid risk of electric shock and fire and to protect from damage, position the main unit as follows:

- Front: Open space with no obstructions.
 - Sides: At least 3cm of space on each side.
 - Top: At least 5cm of space between the top of the unit and the nearest object.
 - Back: At least 15cm of space between the back panel and the nearest object/wall.
 - Bottom: Place the unit on a flat, level surface with no obstructions.
- In addition, maintain the best possible air circulation as illustrated.

Attention: Ventilation Correcte

Pour éviter les chocs électriques, l'incendie et tout autre dégât.

Disposer l'appareil en tenant compte des impératifs suivants

- Avant: Rien ne doit gêner le dégagement
- Flancs: Laisser 3 cm de dégagement latéral
- Dessus: Laisser 5 cm de dégagement supérieur
- Arrière: Laisser 15 cm de dégagement arrière
- Dessous: Rien ne doit obstruer par dessous; poser l'appareil sur une surface plate.

Veiller également à ce que l'air circule le mieux possible comme illustré.

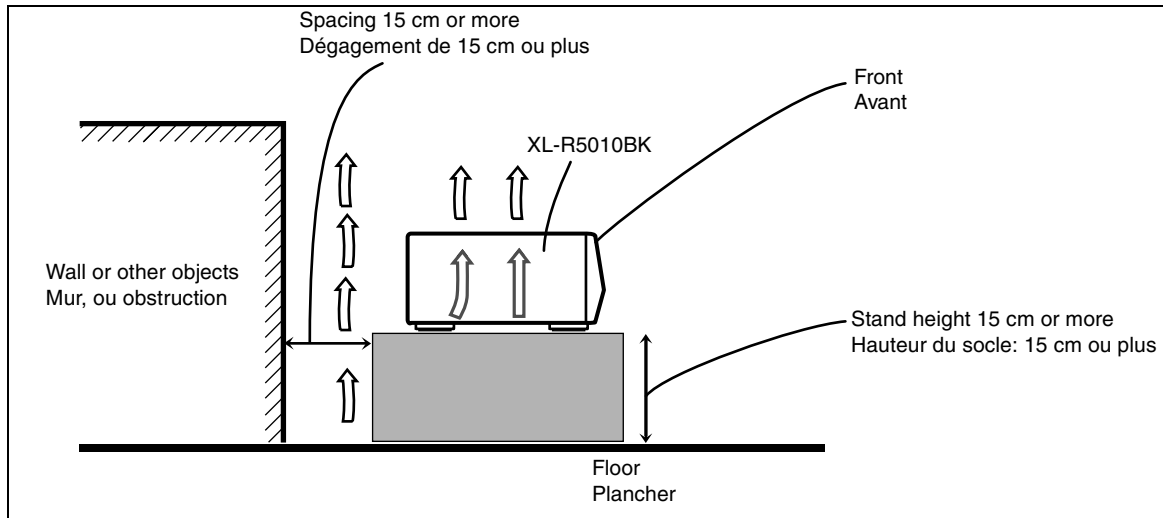



Table of Contents

Precautions	2	Special Recording Edit Operations	33
Features	2	Skipping a Recorded Track on a CD-R or CD-RW (Track Skip).....	33
Connections	3	Erasing a Track or Tracks (Erase Function).....	33
Analog Connections	3	Erasing All Tracks (Disc Erase Function).....	34
Digital Connections.....	4	Finalizing a Disc.....	35
Components.....	5	Making Recording of a Finalized CD-RW Disc Possible (Unfinalize Function)	35
Main Unit	5	Bypassing the FS Converter (Sampling Frequency Converter*) for More Efficient Digital Recording	36
Display Window.....	7	Setting Up Synchronized Start Recording for External Digital Source (CD, MD, and DAT only)	37
Using the Remote Control.....	8	Resetting the Unit to the Factory Default Settings.....	37
Remote Control	8	Setting the Clock	38
Inserting the Batteries	9	Setting the Present Time	38
Using the Remote Control.....	9	Timer Operations.....	40
Power STANDBY/ON Operations	10	Timer Play (wake-up play).....	40
Turning the Power On and Standby Mode.....	10	Timer Recording (Unattended Recording from a Broadcast Receiver or Other Source).....	42
Listening to CDs.....	11	COMPU LINK Function.....	43
3-CD Changer Continuous Playback	11	CD and CDR Messages.....	44
CDR Playback Operations	12	SCMS (Serial Copy Management System).....	46
Using the Remote Control to Control Playback.....	13	Troubleshooting	47
Direct Playback of a Specific Track.....	14	Main Specifications.....	48
Forward and Reverse Search.....	14		
Skipping Tracks	15		
Repeat Playback	15		
Random Playback.....	16		
CD Playback Pitch Control	16		
Disc Lock Function	16		
Programming Playback Using Main Unit Controls	17		
Programming Playback Using the Remote Control.....	18		
Recording onto CD-R/RW Discs	20		
Add Finalize Feature	20		
Manual Recording.....	21		
Synchronized Recording of 3-CD Changer Playback.....	23		
1 Disc Dubbing	25		
Listening Edit Recording	26		
Program Edit Recording.....	27		
3-CD Changer to CDR Recording Options.....	28		
Setting the Unit for High-speed Recording.....	29		
Setting the Auto Track Spacing Function	29		
Synchronized Recording from External Sources	30		
Mixed Input Recording	31		

Precautions

Thank you for purchasing the XL-R5010BK CD/CDR Multiple Compact Disc Recorder. Please read these instructions thoroughly and carefully before using the unit to ensure that you will obtain optimum performance and a long service life.

Safeguarding against electric shock, fire hazards and damage

- 1) A very low electrical current continues to flow when the STANDBY/ON  (power) button is in the standby mode. To save power and ensure safety when the unit is not going to be used for an extended period of time, disconnect the power cord from the wall socket. (See page 10)
- 2) Do not handle the power cord with wet hands.
- 3) To unplug the power cord from the wall socket, always take hold of the molded plug part and pull the plug rather than pulling on the cord.
- 4) If the power cord is damaged or a disconnected wire or worn contact is found, consult the nearest JVC dealership.
- 5) Do not bend the cord at a sharp angle or pull or twist it.
- 6) Do not modify the power cord in any way.
- 7) Do not attempt to disassemble the unit. Do not remove casing screws or touch any of the parts inside the unit.
- 8) Do not insert metallic objects into the unit.
- 9) Unplug the power cord from the wall socket during electrical storms.
- 10) If water should find its way inside the unit, unplug the power cord from the wall socket and consult the nearest JVC dealership.
- 11) Do not install the unit in a poorly ventilated location.

Installation

- 1) Do not place the unit on or next to an amplifier. This is to prevent the humming caused by the unit's proximity to some types of amplifiers. Be sure to place the unit where operation will not be affected by other electrical equipment.
- 2) Do not place the unit in a location where the ambient temperature will exceed 35°C (95°F) (namely, in direct sunlight, near a heating appliance, etc.) or fall below 5°C (41°F), where it is very humid or dusty, or where the unit will be subject to vibration.
- 3) The unit may not function properly if it is moved suddenly from a cold place (0°C, 32°F) to a warm place since condensation may form inside. In such a case, leave the unit in standby mode for about 2 hours, after which time it should function normally.

Disc care

- Storing CDs
 - Always be sure to store each CD in its own case.
 - Do not place CDs in direct sunlight, near a heating appliance or any other location that is susceptible to high temperatures.
- If cellophane tape, a sticker or some other form of adhesive is found on the label side of the disc, clean it off before loading the disc in the unit.
- Do not stick adhesive labels or write anything on a CD.
- Do not bend CDs.
- Do not insert shaped CDs, such as CDs in heart, flower or other shapes, as the shape does not match that of the CD tray, and using such a CD will cause the unit to malfunction.

Cleaning the cabinet

Never use benzine or paint thinners to clean the cabinet as they may mar the unit's surface finish.

Features

The following is a list of some of the functions and conveniences obtained by having a 3-CD changer and CDR combined in a single unit.

- Compatibility between 3-CD changer and CDR assured.
- High-speed recording from source discs in the 3-CD changer to the target disc in the CDR unit (4x for CD-R, 2x for CD-RW).
- Digital optical and coaxial I/O (input/output) terminals, analog I/O terminals, and a microphone jack are provided for external audio signal source connections.
- Sampling frequency converter capable of converting digital signals with sampling frequency of 32 kHz and 48 kHz to digital signals with a sampling frequency of 44.1 kHz for quality recording from a variety of sources.
- No sampling frequency conversion of 44.1 kHz signals for optimal recording of CDs.
- Mixing and recording of 3-CD changer playback and an external source input such as from a microphone, or even combined input from a microphone and another external source.
- Many convenient recording options including: one-button full CD and single track recording, Listening and Program Edit recording, manual recording, synchronized start/stop recording, and mixed input recording.
- CD playback pitch control that can adjust the speed of play up to 12% faster or slower than the normal speed to alter the pitch for singing along with songs or other customized uses.
- Timer playback and timer recording that can be set for one-time or everyday operation.
- OPC (Optimize Power Control), power adjustment performed for best possible recording onto CD-R and CD-RW media.
- COMPU LINK-4 synchronized component operation.

Compatible Disc Formats

The following disc formats can be used for recording in the CDR.

In addition to the marks shown above, the phrases shown below or their equivalent should also be present somewhere on the packaging or accompanying documentation:

**FOR CONSUMER
FOR CONSUMER USE
FOR MUSIC USE ONLY**



Discs that cannot be used for recording are as follows:

- Discs bearing marks other than those shown above
- Discs intended for professional use and/or marked "FOR PROFESSIONAL USE ONLY"
- Discs intended for recording computer data

In addition to the two disc formats shown above, the following disc format can also be played in either the 3-CD changer or CDR.



Notes

- The unit can playback audio data recorded on CD-G, CD-EXTRA and CD-Text discs as well, however the text information of CD-Text discs cannot be displayed.
- If a CD-R or CD-RW has been recorded using a personal computer, playback is only possible if the disc is recorded in the CD-Digital Audio format.
- You can play CD-R and CD-RW discs recorded in the music CD format. Some of them, however, may not be played depending on the disc characteristics or recording condition.
- Do not use a CD-R or CD-RW disc that has been recorded in any format other than the music CD format or a CD-RW disc that has been used in any format other than the music CD format with this unit. Using such a disc with this unit may cause loud sound to damage the speakers or cause hearing disorder.

Notes on playing unfinalized CD-R or CD-RW discs with the 3-CD changer

- It will take some time before play starts.
- CD-R or CD-RW discs of the short recording time may not be played.
- An unfinalized CD-RW may not be played properly. For example, sound files that you have deleted may be played. In such a case, finalize the disc first or use the CDR of this unit for play.
- You cannot skip tracks on an unfinalized CD-R or CD-RW disc.

Do not turn on the power until all connections have been completed.

Analog Connections

Use the accessory pin cables to connect this unit's LINE terminals with those for the TAPE/CD/VCR on the receiver, etc.

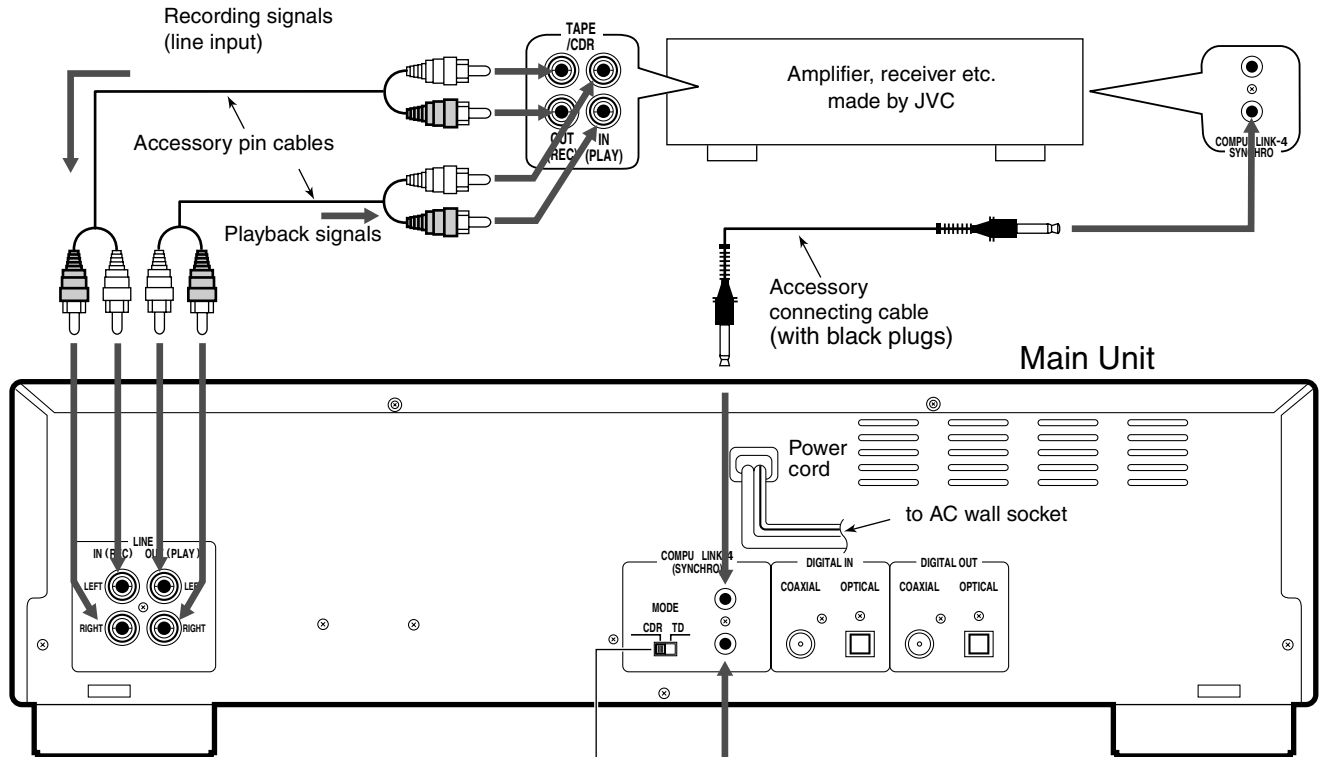

Selecting a COMPU LINK-4 MODE switch position

- When connected with CDR input/output terminals of the amplifier or receiver
- When connected with TAPE input/output terminals of the amplifier or receiver



- For more details regarding COMPU LINK, see page 43.

Note

- The COMPU LINK-4 feature is only supported by other JVC products also equipped with the COMPU LINK feature. Please check the manual(s) of your JVC product for compatibility.
- Before selecting the COMPU LINK-4 MODE switch position (CDR or TD), turn off the power and disconnect the power cord from the wall socket. The function cannot be reset while the power is on. Alternatively, if the COMPU LINK-4 MODE switch position (CDR or TD) is changed while the power is on, turn off the power, disconnect the power cord and then reconnect it. The new setting will be read into the system when power to the main unit is turned back on.
- Misconnections can be avoided by using the white plugs on the accessory pin cables for the LEFT channel and the red plugs for the RIGHT channel.
- Insert the plugs all the way in. Incomplete connections may cause noise.
- When plugging the power cord into the AC outlet, be sure to match the width of the plug blades with the outlet.

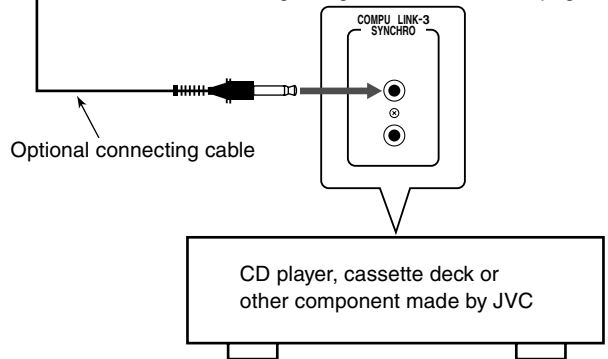

Digital Connections

Digital Optical and Coaxial Cable Connections

Optical Cable Input/Output Terminals

- Connect a receiver or amplifier with digital audio capability via the optical Input/Output cables. A single cable transmits stereo signals (L/R channels) as digital data.
- If analog audio connections are also being made, try using the digital connectors on the receiver/amplifier that are labeled digital terminals on the receiver or amplifier that are labeled the same way as the analog terminals.
- Make sure the optical cable (not supplied) can be connected to the amplifier, etc. before purchasing it.
- Do not bend the optical cable at a sharp angle.

- The filament in the cable shines red when activated. This beam sends the digital signal. It is not harmful to the eyes, but please keep the protective cap on the terminal when not in use.

Notes

- Connect an external digital recording device to the digital output terminal on an amplifier or receiver, and then connect the amplifier or receiver to this unit.
- The sound from an external device cannot be digitally output from this unit. To listen to the sound from the external device, connect an amplifier or receiver to the LINE OUT (PLAY) terminal on this unit.

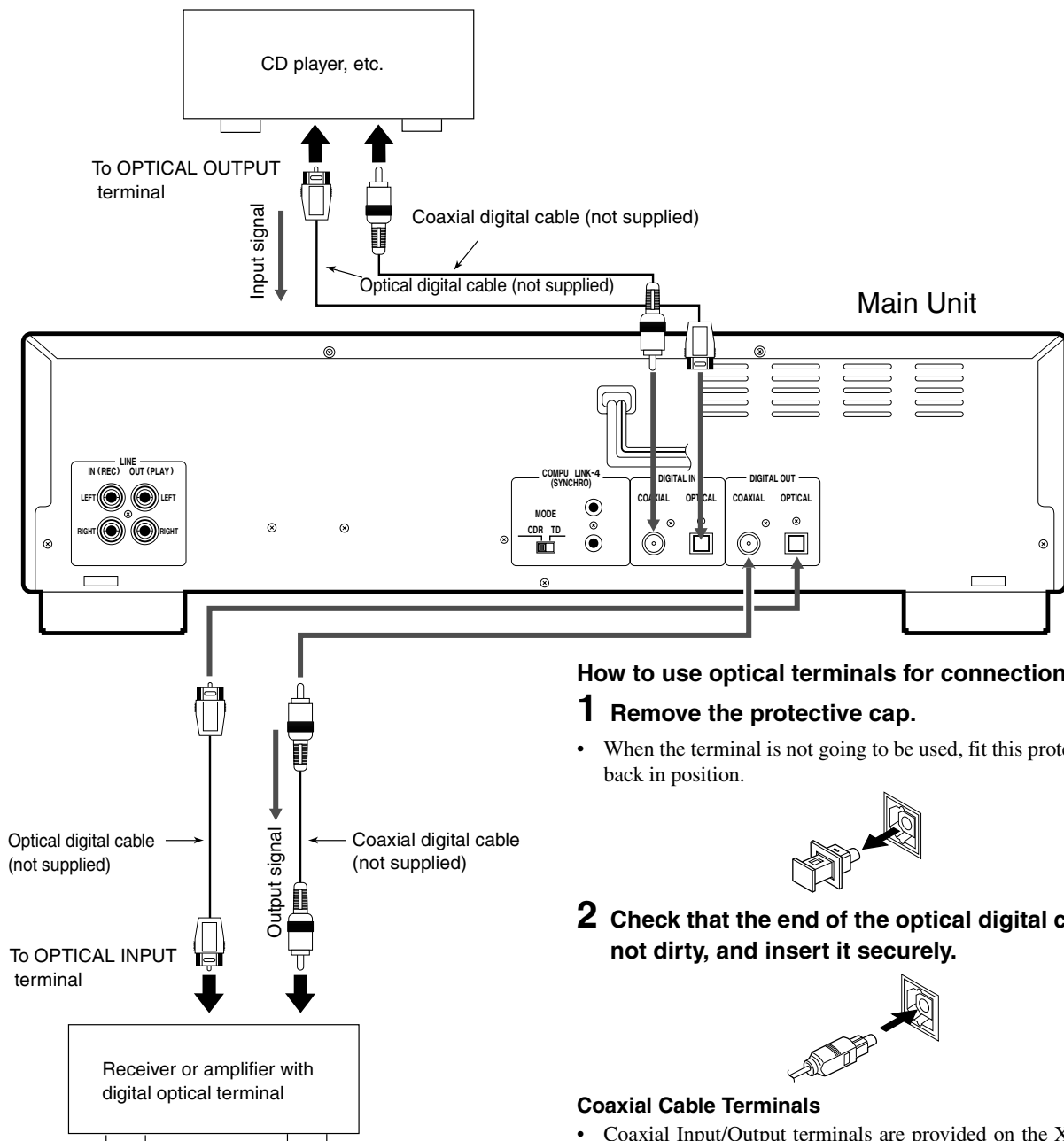

How to use optical terminals for connections

1 Remove the protective cap.

- When the terminal is not going to be used, fit this protective cap back in position.

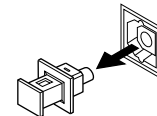

2 Check that the end of the optical digital cable is not dirty, and insert it securely.

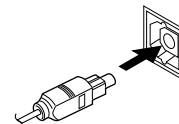

Coaxial Cable Terminals

- Coaxial Input/Output terminals are provided on the XL-R5010 for enhanced connectivity. Simply connect the corresponding Input/Output terminals of other components using coaxial cables for fast, easy data transfer.

Main Unit

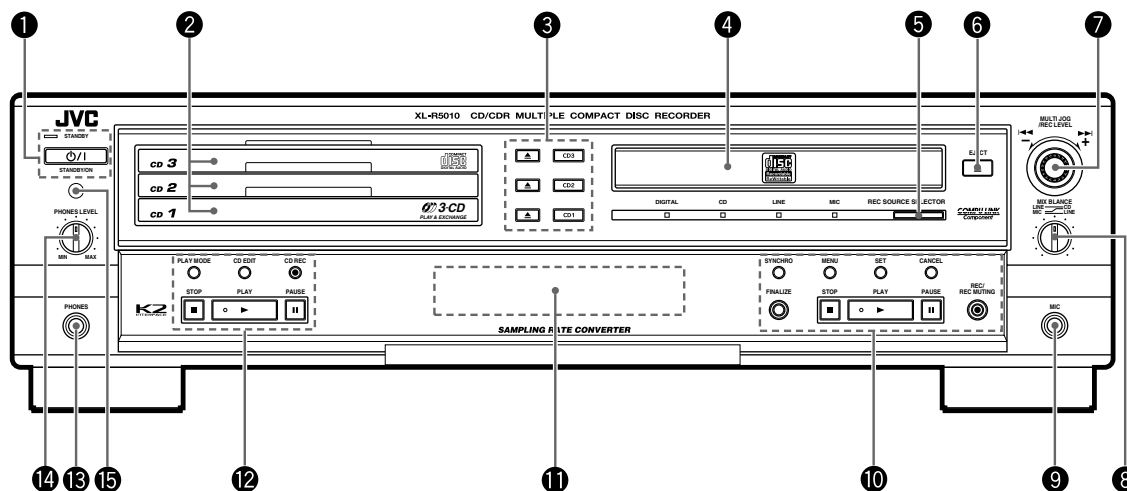

Description (For details, refer to page in parentheses.)

① STANDBY/ON $\text{\textcircled{I}}$ button and STANDBY lamp

Press to turn the power on or to put the unit in standby mode. When the unit is in standby, the STANDBY lamp is lit. (see page 10)

② CD Trays 1, 2, and 3 (numbered from bottom to top)

Load CDs in these trays for 3-CD changer playback. (see page 11)

③ Disc Tray Selector and \blacktriangle (Eject) Buttons

Press to select the tray(s) that you want to play when CDs are loaded in the 3-CD changer. Icons show the currently selected trays in the display window. Use the \blacktriangle (Eject) buttons to open and close the corresponding disc trays. (see page 11)

④ CDR Disc Tray

Load a recordable CD-R or CD-RW in this tray for recording. CD playback is also possible using this tray.

⑤ REC SOURCE SELECTOR and Source Selection Lamps

Use to select the type of source the signal is to be recorded from. The selected source is indicated by activation of the lamp under the source name (located to the left). (see page 21, 30)

⑥ EJECT Button (\blacktriangle)

Press to open and close the CDR disc tray.

⑦ MULTI JOG/REC LEVEL Control

Use this control for selecting and setting use options, changing clock settings, skipping forward/backward through tracks on a CD, etc. Also use it to adjust the level of the source signal when recording discs.

⑧ MIX BALANCE Control

Use the MIX BALANCE control to adjust the mixing levels of independent signals being recorded simultaneously. (see page 32)

⑨ MIC (Microphone) Jack

Use this jack to connect a microphone (not supplied) to the unit for recording.

⑩ CDR Control Operation Buttons

SYNCHRO: Press to select synchronized recording. (see page 30)

MENU: Press to enter the menu options.

SET: Press to enter an operation or selection.

CANCEL: Press to cancel an operation or selection.

FINALIZE: Press to finalize a CD-R/RW disc when recording has been completed. (see page 35)

STOP \blacksquare : Press to stop recording or playing of the CDR. (see page 11, 22)

PLAY \blacktriangleright : Press to start playing, or resume recording if the CDR is in the recording pause mode. (see page 11, 21)

PAUSE $\text{\textcircled{II}}$: Press to pause play or recording. (see page 12)

REC/

REC MUTING: Use to start recording, or when recording to mute the recording signal. (see page 21, 22, 26, 31)

⑪ Display Window

Displays operation modes and system information. (see page 7)

12 CD Control Operation Buttons

PLAY MODE: Press repeatedly to select one of the play modes for the 3-CD changer. (see page 16, 17)

CD EDIT: Press to select either Listening Edit or Program Edit recording mode. (see page 26, 27)

CD REC: Press to perform synchronized recording of the currently selected CD in the 3-CD changer. (see page 23, 24)

STOP■: Press to stop play of the selected disc in the 3-CD changer. (see page 11)

PLAY▶: Press to start play of the selected disc in the 3-CD changer. (see page 11)

PAUSE■: Press to pause play of the selected disc in the 3-CD changer. (see page 11)

13 PHONES (Headphones) Jack

Use this jack to connect headphones (not supplied) to the unit.

14 PHONES LEVEL (Volume) Control

Use this to adjust the volume being output to headphones connected to the unit.

Note

In this manual, procedures using buttons on the front panel of the unit are depicted by the name of the button in capital letters with the button illustration immediately after it. Procedures using the buttons on the remote control are depicted by the button illustration with the name of the button in small letters and parentheses immediately after it.

Example: CD Control PAUSE ■ button Front panel ■ (pause) button Remote control

15 Remote Control Sensor

This sensor receives commands from the remote control.

Display Window

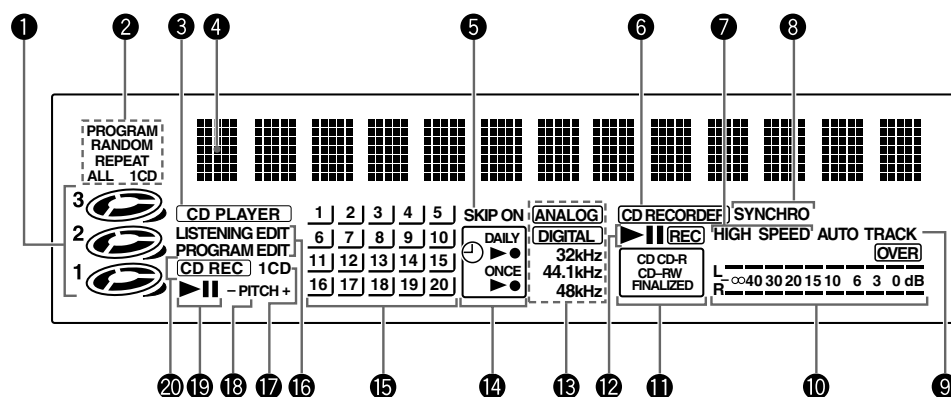

1 CD numbers and play status displays

Indicate whether discs are loaded in any of the 3-CD changer disc trays, which disc is currently selected, and the operation status of the current disc. (see page 12)

2 PLAY MODE indicators

Light according to which play mode has been selected.

3 CD PLAYER indicator

Lights when the 3-CD changer is selected for play.

4 Information display

Displays track, time, and operation information.

5 SKIP ON indicator

Lights when the currently selected disc contains SKIP TRACK markers.

6 CD RECORDER indicator

Lights when the CDR has been selected for play or recording.

7 HIGH SPEED indicator

Lights when the high-speed (4x, 2x) recording function is being performed. (see page 29)

8 SYNCHRO (synchronized) recording indicator

Lights to indicate synchronized recording is on. (see page 24)

9 AUTO TRACK indicator

Lights when automatic track marking has been turned on. (see page 23)

10 Level meters

Indicate the levels of the right and left channels during playback and recording operations. When the input signal exceeds 0 dB, the OVER indicator lights. (see page 22)

11 Disc format indicators

Light to indicate the type of disc that is loaded in the CDR, and whether or not it is finalized.

12 CDR deck operation indicators

Light to indicate the operation mode of the CDR.

13 Recording type indicators and sampling frequency indicators

Light to indicate whether the recording is analog or digital. During digital recording, the appropriate frequency indicator lights to indicate the sampling frequency of the source being played back.

14 Timer operation indicators

Indicate that a Timer play or recording function has been set, and whether it is set for everyday or one-time operation.

15 Music calendar

Indicates the number of tracks on the currently selected CD or CDR, and the track on the disc that is being played or recorded.

16 EDIT recording indicators

Indicates if the listening edit or program edit mode is being used. (see page 26, 27)

17 1CD indicator

Lights at the time either the 1CD or 1 Track recording mode is selected. Also lights together with REPEAT and 1CD of the PLAY MODE indicators if PEPEAT 1 is selected when setting the repeat play mode. (see page 15)

18 PITCH (+/-) indicators

Indicate that the pitch of CD play has been adjusted in one direction or the other. (see page 16)

19 3-CD changer operation indicators

Light to indicate the operation mode of the 3-CD changer.

20 CD REC indicator

Indicates a CD loaded in the 3-CD changer is being recorded by the CDR.

Using the Remote Control

Remote Control

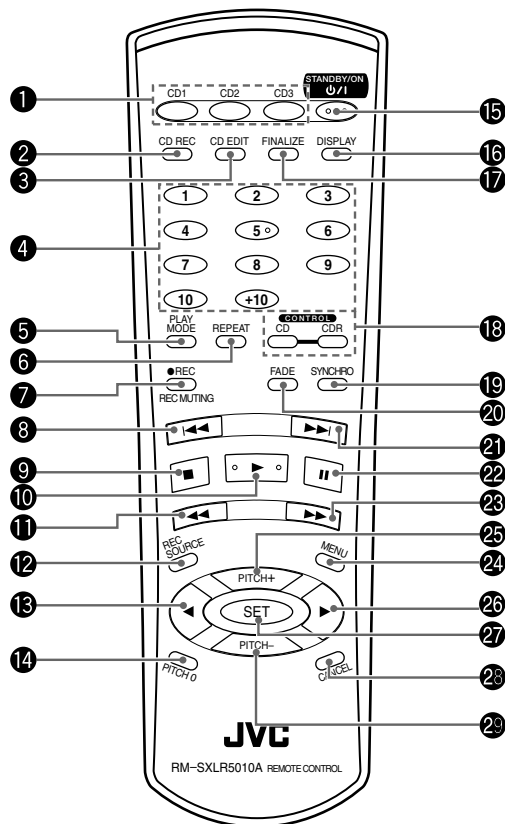

When following the procedures in this manual, the buttons on the remote control have the same function as the corresponding buttons on the main unit.

1 CD1, CD2, CD3 Disc Selection Buttons

Use these to select the disc(s) to be played by the 3-CD changer. (see page 10, 14)

2 CD REC Button

Press to start the CD REC function. (see page 23, 24)

3 CD EDIT Button

Press repeatedly to select Listening Edit or Program Edit functions. (see page 26, 27)

4 Number Buttons

Press to select tracks for playback. (see page 14)

5 PLAY MODE Button

Press repeatedly to select a play mode for the 3-CD changer. (see page 16)

6 REPEAT Button

Press repeatedly to select one of the repeat play modes. (see page 15)

7 ● REC/REC MUTING Button

Press to put the unit into recording pause mode from CDR stop mode.

Press to mute recording signal during recording. (see page 22, 27)

8 ◀◀ (reverse skip) Button

Press to skip back to the beginning of previous tracks. (see page 15)

9 ■ (stop) Button

Press to stop playback of the currently selected disc in the 3-CD changer or stop playback/recording of the disc in the CDR. (see page 13)

10 ▶ (play) Button

Press to play the currently selected CD. (see page 13)

11 ◀◀ (reverse) Button

Press to perform fast reverse search of the CD currently being played. (see page 14)

12 REC SOURCE Button

Press to select the source for recording to the CDR.

13 ◀ MULTI JOG Control (menu) Button

Press to select menu operations.

14 Pitch 0 Button

Press to restore playback speed of the CD player to normal.

15 STANDBY/ON ⏻/⏻ Button

Press to turn the power of this unit on or to put it in the standby mode. (see page 10)

16 DISPLAY Button

Press to change the type of information that is shown in the information display (see page 24).

17 FINALIZE Button

Press to start finalization of a CD-R or CD-RW. (see page 35)

18 CD and CDR Deck Selection Buttons

Press to select the type of operation you want to use, 3-CD changer or CDR. (see page 14)

19 SYNCHRO Button

Press to select synchronized recording. (see page 30)

20 FADE Button

Press to create fade-in and fade-out of data being recorded. (see page 22)

21 ▶▶ (forward skip) Button

Press to skip forward to other tracks on the disc. (see page 15)

22 || (pause) Button

Press to pause playback of the currently selected disc. (see page 13)

23 ▶▶ (forward) Button

Press to perform fast forward search of the currently selected CD. (see page 14)

24 MENU Button

Press to access Menu options.

25 PITCH+ Button

Press to increase the speed of CD playback.

26 ▶ MULTI JOG Control (menu) Button

Press to select menu operations.

27 SET Button

Press to enter a selection on the menu. Also used for registering tracks in the program mode.

28 CANCEL Button



Press to cancel an operation.

29 PITCH- Button

Press to decrease the speed of CD playback.

Note

In this manual, procedures using buttons on the front panel of the unit are depicted by the name of the button in capital letters with the button illustration immediately after it. Procedures using the buttons on the remote control are depicted by the button illustration with the name of the button in small letters and parentheses immediately after it.

Example: CD Control PAUSE  button Front panel  (pause) button Remote control

Inserting the Batteries

- 1 Press down on the point shown by the arrow at the top of the compartment cover, and lift the cover to open the compartment.

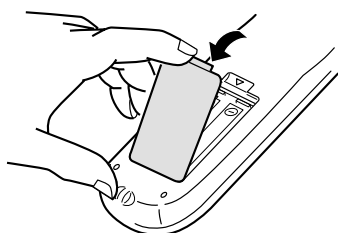

- 2 Place the two accompanying R6P(SUM-3)/AA(15F) batteries in the remote control making sure to match the battery polarities with the markings (“+”/“-”) inside the compartment.

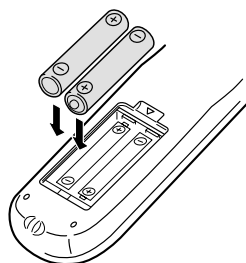

- 3 Place the cover over the compartment and press down lightly until it locks in place.

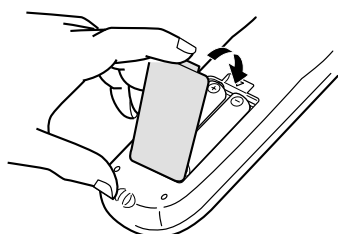

Using the Remote Control

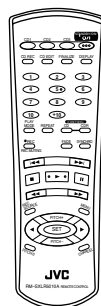
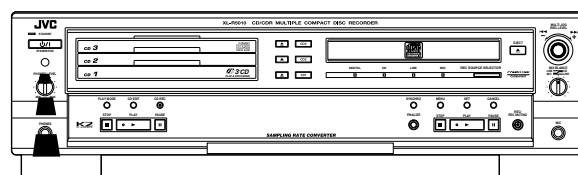

- Point the remote control toward the left side of the front panel of the main unit before you begin pressing buttons.
- The remote control can be operated at a distance of up to approximately 7m (23ft) or so from the main unit. This distance will be less if the remote control is operated from a position that is not directly in front or on the same level as the main unit.
- When the distance over which the remote control can be operated starts to drop, it means that the batteries are nearing the end of their service life.
- Replace both R6P(SUM-3)/AA(15F) batteries with new batteries.
- The dry-cell batteries provided with the unit are for the purpose of checking system operations only. Replace them with new batteries as soon as possible.
- Do not drop the remote control or subject it to strong impact.
- In order to ensure that the remote control does not fail to operate, avoid the following conditions:
 - Exposure of the main unit and remote control to direct sunlight or other intense sources of light.
 - Objects blocking the path of signals being transmitted from the remote control to the main unit.

Power STANDBY/ON Operations

Turning the Power On and Standby Mode

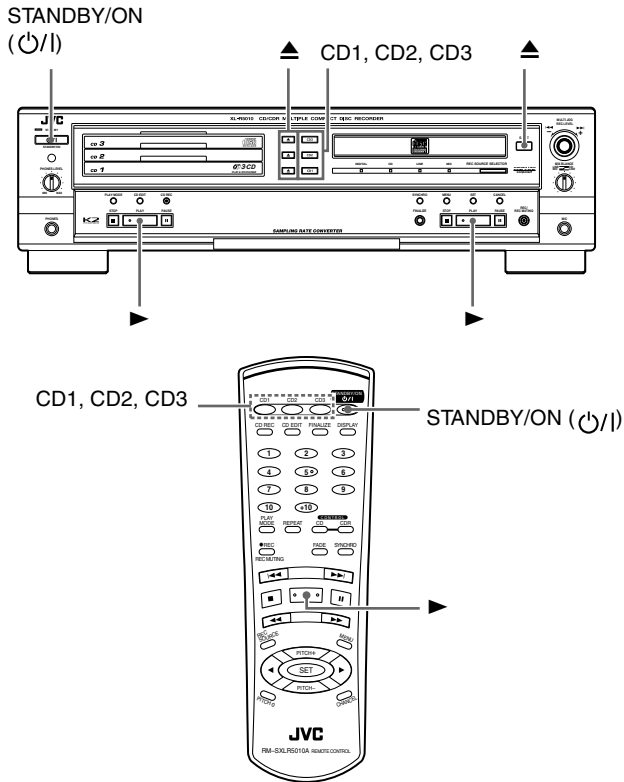

To turn power to the unit on

Press the STANDBY/ON button on the front panel or remote control.

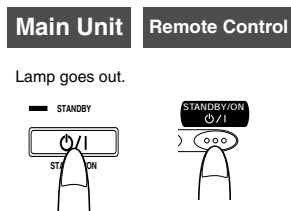

- The currently selected CD function is shown in the information display.

To put the unit in standby mode during operation

Press the STANDBY/ON button on the front panel or remote control.

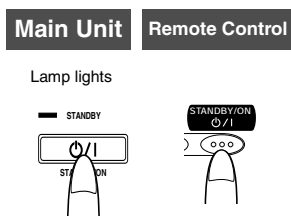

- The clock display is shown in the information display. It flashes if the clock has not been set.
- The unit can be put into the standby mode by pressing the STANDBY/ON button.

If the STANDBY/ON button is pressed during a recording operation, the standby lamp flashes while the unit brings the operation to an end. Once the operation has stopped, the unit enters the standby mode and the standby lamp lights steady. From the time the button is pressed until the standby lamp lights steady, the unit will not respond to any button pressed on the front panel of the main unit or remote control.

Turning the power on by pressing a function button when the unit is in the standby mode

The unit can be turned on and a function selected simply by pressing one of the buttons shown in the figure below

	Function	Operation
Main unit Remote control 	3-CD changer	The function is set to 3-CD changer. The CD PLAYER indicator is shown in the display window. If one of these buttons is pressed when a CD is in the corresponding CD tray, continuous play starts from the CD tray corresponding to the button pressed. These buttons do not function during program and random play modes.
Main unit (3-CD control) 	3-CD changer	The function is set to 3-CD changer. The CD PLAYER indicator is shown in the display window.
Main unit (CDR control) 	CDR	The function is set to CDR. The CD RECORDER indicator is shown in the display window.

- When the PLAY button for either the 3-CD changer or CDR is pressed on the main unit, the power is turned on and the corresponding tray is selected. If a disc is loaded in the selected tray, playback begins.
- When one of the 3-CD changer EJECT buttons or the CDR EJECT button is pressed, the power is turned on and the tray opens, but the currently selected function (3-CD changer or CDR) does not change.
- When the play button on the remote control is pressed, the power is turned on, the last selected function (3-CD changer or CDR) is recalled and the corresponding tray is selected. If a disc is loaded in the selected tray, playback begins.
- If the power cord is unplugged from the wall socket for more than a few seconds, the internal clock, program, etc. of the main unit may require resetting. When this occurs, please set the clock (and timer functions) again.

3-CD Changer Continuous Playback

Compatible CDs

The 3-CD changer can be used to play back general audio CDs, CD-R and CD-RW media.

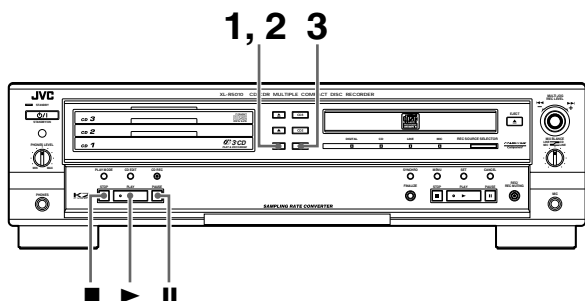

Example: Loading a CD for playback in tray CD1.

1 Press the CD1 EJECT ▲ button to open the tray.

- The power comes on, and tray CD1 opens.

2 Load a CD in position and close the tray by pressing on the CD1 EJECT ▲ button again.

Place the CD with its label side facing up.

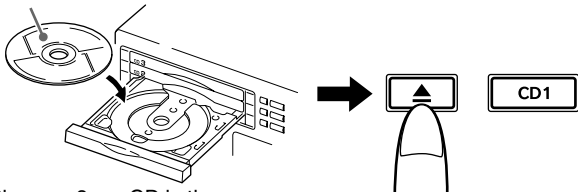

Place an 8-cm CD in the center cutout.

- “CD (*) READ DISC” flashes in the information display while the disc is being read.
- Follow steps 1 and 2, repeating the process for CD2 and CD3, pressing the appropriate EJECT ▲ buttons, and load CDs in trays CD2 and CD3 as well.
- The unit will not respond to commands when a specified tray is being opened or closed or while the unit is switching CD trays.
- 3-CD changer trays cannot be opened during the recording operation even if recording is being performed from an external source. (This is a safety feature that prevents the possible noise and vibration created by other operations from lowering the quality of the recording in process.)

3 Press the CD1 button.

- The function is set to CD, and CD1 playback starts from track 1.

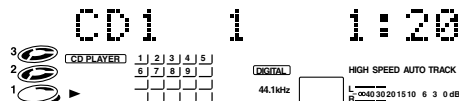

- The track number is cleared from the music calendar when the corresponding track has finished playing.
- In this example, playback proceeds through all of the tracks on CD1, CD2 and CD3, and stops automatically after the last track on CD3 has finished playing. This pattern changes depending on the first disc selected for play, as described in the following section.

When one or more CDs are already in the trays.

- Press the button of the CD tray that you want to start playback from. Continuous play will start playback from the CD in that tray. If a CD tray button is pressed when the unit is in the standby mode, continuous play will start from the tray selected when the power is turned on.
- **When play starts from CD2**
The CDs are played in the sequence of CD2 → CD3 → CD1, and then playback stops automatically.
- **When play starts from CD3**
The CDs are played in the sequence of CD3 → CD1 → CD2, and then playback stops automatically.
If one of the trays does not contain a CD, play skips to the CD in the next tray in the sequence.

Notes

- The CD1, CD2, and CD3 buttons do not function during program and random play modes.
- If a tray is opened and closed when it is not the current tray in use, the unit temporarily assigns the tray a NO DISC status. When it becomes time to play the disc in this tray, the disc information is read, and if there is no disc, the unit will move on to the next tray.
- The total track time does not always match total play time (time shown in display window) exactly because the playback time includes lead-in and lead-out spaces as well.

Playing CDs using the CD Control PLAY ► button

Press the CD Control PLAY ► button to select the 3-CD changer function. This automatically starts playback of the disc in the currently selected tray.

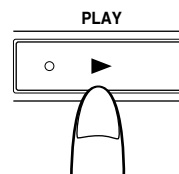

- The currently selected tray is indicated by the red “◀” mark appearing to the immediate right of the CD icon in the display window.

(To be continued on the next page)

Stopping CD playback

To stop playback at any time

- Stop playback of a disc in the 3-CD changer by pressing the CD Control STOP ■ button. The total number of tracks and playing time is shown in the information display.

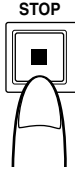

- When all the tracks on a CD have been played through, playback stops automatically.

To stop playback temporarily

- If the CD Control PAUSE || button is pressed, playback is paused temporarily. When the CD Control PLAY ► button is pressed, playback resumes from the place where it was paused.



- This button works when the 3-CD changer is selected as the playback source.

Removing a CD from the 3-CD changer

To remove a CD from the 3-CD changer, press the EJECT ▲ button next to the tray holding the CD to be removed. To remove the CD that is currently being played back, it is recommended that playback first be ended by pressing the CD Control STOP ■ button before pressing the EJECT ▲ button. After pressing the EJECT ▲ button, the tray will open and the CD can be removed. Press the EJECT ▲ button once more to close the tray.

Number of CDs and play status display

The display window shows whether or not a CD has been loaded into each of the CD trays as well as the play status of the CD.

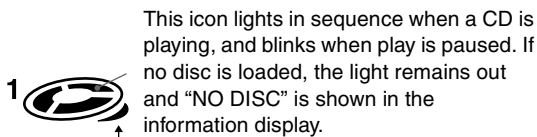

This lights when the CD in the tray has been selected to be played.

CDR Playback Operations

The CDR can play general audio CDs, CD-R and CD-RW media.

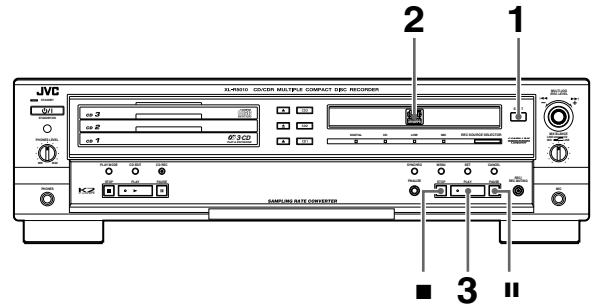

1 Press the CDR EJECT ▲ button to open the CDR disc tray.

2 Load a disc in position and close the tray by pressing the CDR EJECT ▲ button again.

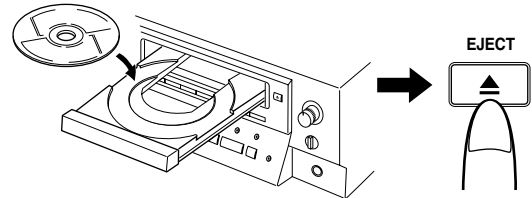

- When a CD-R or CD-RW is loaded in the CDR, the unit determines the format of the disc and whether it is finalized or not.

3 Press the CDR Control PLAY ► button to select the CDR function and start playback at track 1.

- Playback stops automatically at the end of the last track on the disc.

To stop CDR playback

- Stop playback of a disc in the CDR by pressing the CDR Control STOP ■ button. The total number of tracks and play time will be shown in the information display.

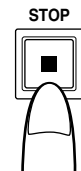

To stop CDR playback temporarily

- Pressing the CDR Control PAUSE **||** button at any time when a CD is playing in the CDR pauses playback. Press the CDR Control PLAY **▶** button to resume playback.

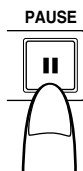

- When playback is paused, the **||** indicator is shown in the display window.

Removing a CD from the CDR

- To remove a CD from the CDR, press the CDR EJECT **▲** button. To remove a CD when it is being played back, it is recommended that playback first be ended by pressing the CDR Control STOP **■** button before pressing the EJECT **▲** button. After pressing the EJECT **▲** button, the tray will open and the CD can be removed. Press the EJECT **▲** button once more to close the tray.

Notes

- When an unfinalized CD-R or CD-RW is loaded in the CDR and the CDR EJECT **▲** button is pressed to open the CDR disc tray, "FINALIZE?" is shown in the information display. If you do not wish to finalize the CD at that time, press the CDR EJECT **▲** button again. For more information on finalizing a CD, see page 28.
- If playback of an unfinalized disc is stopped or if tracks are skipped (forward or reverse), some data of the track (or beginning of next track in the case of skipping) may be cut (not read) when playback starts again.
- The total track time does not always match total playback time (time shown in the information display) exactly because the playback time includes lead-in and lead-out spaces as well.

Using the Remote Control to Control Playback

The buttons on the remote control can be used to control 3-CD changer playback and CDR recording and playback. When using the remote control, be sure to point it directly at the front lefthand side of the main unit (facing you) when pressing the buttons.

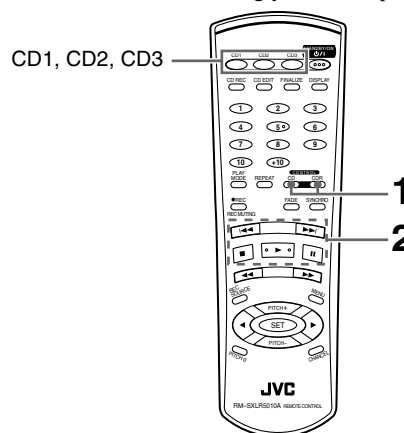

1 Press the CD or CDR button to select the device.

CD button: To control discs in the 3-CD changer

CDR button: To control the disc in the CDR

- Pressing the CD1, CD2 or CD3 button automatically sets the unit to the 3-CD changer and starts playback of the disc in the selected tray.
- When the CD function is selected, the CD PLAYER indicator is shown in the display window. When the CDR function is selected, the CD RECORDER indicator is shown.

2 Press the command button of the operation you want to perform.

- The buttons on the remote control perform the same operations as the corresponding buttons on the main unit.
- The command is applied to the 3-CD changer or CDR depending on the function currently selected.

Direct Playback of a Specific Track

CD playback can be started from a specific track by pressing the corresponding number button(s) on the remote control.

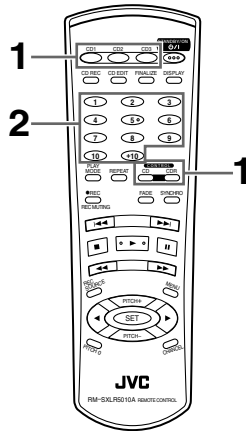

- 1 Press the CD and CDR Deck Selection button corresponding to the tray holding the CD and track to be played.

For a CD in the 3-CD changer

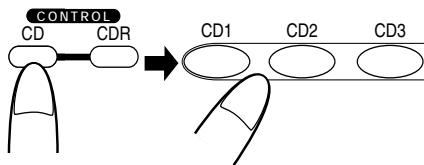

For a CD in the CDR

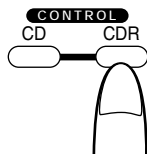

- 2 Press the number button(s) of the track you want to play.

The track number corresponding to the buttons pressed is shown in the information display, and playback of that track starts.

To select tracks 1 through 10

Press the number button (1 through 10) corresponding to the track.

To select tracks 11 or above

First press the +10 button, and then press one of the number buttons 1 through 10.

Example: Track 15

Press +10 followed by 5.

Example: Track 20

Press +10 followed by 10.

Direct Track Selection (selecting another track during playback)

Press the number button(s) corresponding to the track to be played (Step 2). The display will change to indicate the corresponding track number, playback of the current track will stop and playback of the newly selected track will begin.

- To select a track on a CD in another tray, repeat steps 1 and 2.
- Direct track selection cannot be initiated by pressing the +10 button alone: this button must be used in combination with one of the other number buttons (1 through 10). This function is not possible when either program or random play mode is in use.

Forward and Reverse Search

The ◀◀ (reverse) and ▶▶ (forward) buttons on the remote control can be used to find a particular location on the CD being played.

- 1 Press the CD and CDR Deck Selection button (CD or CDR) corresponding to the tray holding the CD currently playing.
- 2 Press the ◀◀ (reverse) or ▶▶ (forward) button corresponding to the direction you want search. Release the button when you find the location you want to play.

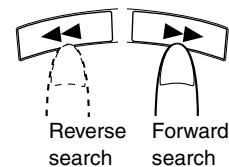
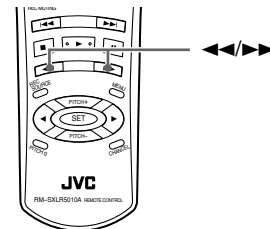

- If playback is paused when a search is performed, there is no sound heard during the search. When the search is complete the pause mode is resumed.
- When forward or reverse searching is performed during playback of an unfinalized disc, the information display and/or the search function may not operate properly depending on the type of disc being played.

Skipping Tracks

To skip forward or backward to different tracks on the currently selected CD, use the MULTI JOG control on the main unit or the ◀◀ (reverse) or ▶▶ (forward) buttons on the remote control.

MULTI JOG control

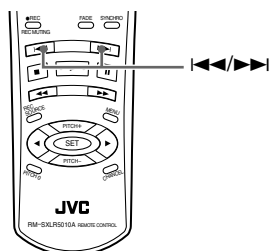
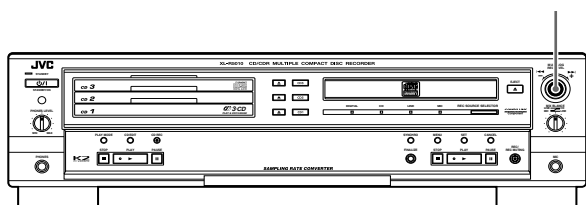

- When the last track on a CD loaded in the 3-CD changer is advanced to the next track, playback moves to the first track on the next CD. It is not possible to skip forward when playing the last track of a CD loaded in the CDR.

Main Unit

- Turn the MULTI JOG control counterclockwise one notch to return to the beginning of the current track, or keep turning it until the track number you are searching for is shown in the information display.
- Turn the MULTI JOG control clockwise one notch to move to the beginning of the next track, or keep turning it until the track number you are searching for is shown in the information display.

Remote Control

Press the CD and CDR Deck Selection button (CD or CDR) corresponding to the tray holding the CD currently playing, and then press the desired search direction.

- Press the ◀◀ (reverse skip) button once to return to the beginning of the current track, or press it repeatedly until the track number you are searching for is shown in the information display.
- Press the ▶▶ (forward skip) button once to move to the beginning of the next track, or press it repeatedly until the track number you are searching for is shown in the information display.

Repeat Playback

The repeat playback mode can be selected by pressing the REPEAT button on the remote control when the main unit is set to either 3-CD changer or CDR function. Please note, however, that the REPEAT ALL setting (for repeating all of the CDs loaded in the 3-CD changer) can only be set when the main unit is set to 3-CD changer (CD PLAYER indicator is shown in display window).

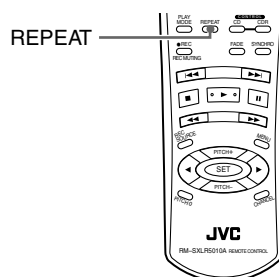

Setting the repeat play mode

Press the REPEAT button on the remote control. The REPEAT indicator will be shown in the PLAY MODE section of the display window. Press the button repeatedly to choose the desired setting. The selection in the information display changes in the following order:

“REPEAT ALL” : Repeat playback of all of the CDs loaded in the 3-CD changer (3-CD changer only).



“REPEAT 1CD” : Repeat playback of the CD currently playing



“REPEAT 1” : Repeat playback of the track currently playing



Repeat off (normal display).

Using repeat mode during program or random play modes

If the repeat playback mode is activated while the unit is in the program or random play modes, the following settings are possible:

“REPEAT ALL” : Random mode - Repeats random playback of all of the CDs loaded in the 3-CD changer.

Program mode - Repeats playback of the entire program.

“REPEAT 1” : Repeats playback of the track currently playing.

The setting selection will be shown by the ALL or 1CD indicator being lit in the PLAY MODE section of the display window.

Notes

- Repeat playback mode cannot be used during CD REC or CD EDIT recording operations.
- Play is repeated in the selected mode when the CD1, CD2 or CD3 button (main unit or remote control), CD Control PLAY ▶ button of the main unit or ▶ (play) button of the remote control is pressed.

Random Playback

When in the 3-CD changer stop mode (CD PLAYER indicator is shown in the display window), press the PLAY MODE button (main unit/remote control) repeatedly until "CD RANDOM" is shown in the information display. The RANDOM indicator will be shown in the PLAY MODE section of the display window.

Note

The random playback mode cannot be used for discs loaded in the CDR.

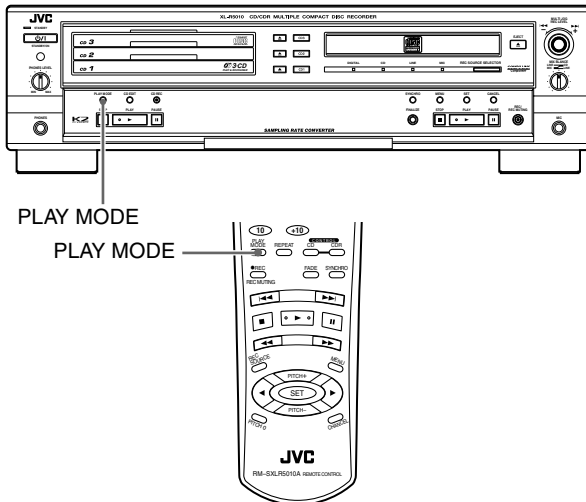

- Random play is started by pressing the CD Control PLAY ► button on the main unit or the ► (play) button on the remote control.
- When activated, tracks are chosen randomly for playback from the CDs loaded in the 3-CD changer. The tracks chosen will be lit in the music calendar and the SKIP ON lamp turns off.
- Selection is made only once, from 1 to 99 tracks, and playback ends after the last track is played.
- Tracks assigned a SKIP TRACK mark will not be chosen.
- The CD tray, track number and playback time of the CD currently being played are shown in the information display.
- Track selection via the 10-key input is not accepted during the random playback mode.

To release the random playback mode

When the unit is in the 3-CD changer stop mode, press the PLAY MODE button repeatedly until the RANDOM indicator is cleared from the PLAY MODE section of the display window.

CD Playback Pitch Control

There are 3 CD pitch control buttons on the remote control that can be used to vary the speed of CD playback up to 12% faster or slower than the standard playback speed. This function can be useful in changing the pitch when adding vocals to a recording using the microphone input or when matching the playback speed of the CD with another source.

To adjust the pitch of a CD during playback

To raise the pitch of CD playback (i.e., increase the speed of playback), press PITCH+. Likewise, to lower the pitch of CD playback (i.e., slow down the speed of playback), press PITCH-. Each press of a button raises or lowers playback speed 1% (up to 12% max.)

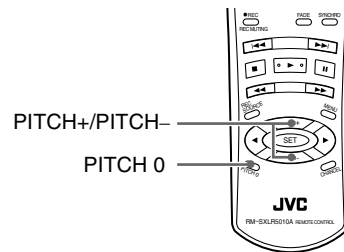

- To restore the playback speed to normal, press PITCH 0.
- The adjusted playback speed can only be recorded using analog recording functions such as mixed recording.
- Even if the pitch has been adjusted, when digital synchronized recording is performed, the pitch is automatically restored to 0 before recording begins.
- The amount of pitch adjustment (+/-0) is shown in the information display when one of the pitch buttons is pressed.
- When the speed of CD playback is changed using the pitch control buttons, there is no signal output from the DIGITAL OUT OPTICAL terminal.
- Pitch control cannot be used for the CDR.

Disc Lock Function

The Disc Lock function can be used to make it impossible for children or anyone else to take CDs out of or load new ones into the 3-CD changer and CDR. This function helps to ensure that timer play and recording functions are performed correctly.

- When the power is in standby, press the CD1 EJECT ▲ button while holding down the CD Control STOP ■ button on the front panel. "TRAY LOCKED" will be shown in the information display for 3 seconds, after which it is no longer possible to remove from or load CDs into the unit.

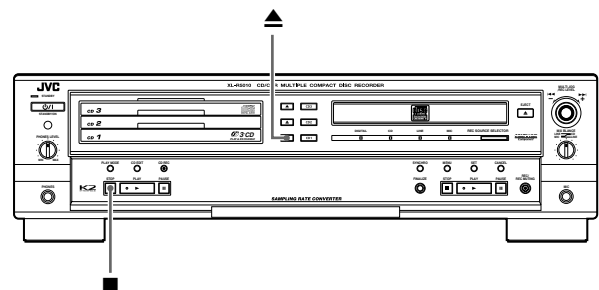

To cancel the Disc Lock function.

Repeat the same step followed to lock the trays. "TRAY UNLOCKED" will be shown in the information display for 3 seconds, after which the Disc Lock function is canceled.

Note

The Disc Lock function is canceled if the AC power cord is unplugged from the wall outlet.

Programming Playback Using Main Unit Controls

It is possible to select your own program (order of tracks being played) using the program playback mode. Any of the tracks (1-99) on the CDs in the trays of the 3-CD changer can be selected. If you want to program and record tracks, see “Program Edit Recording” on page 27.

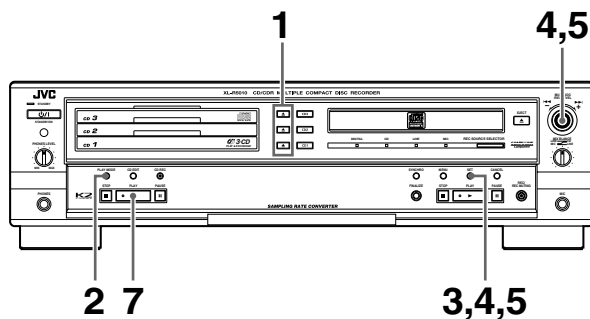

1 Load CDs into the trays of the 3-CD changer.

- Only tracks on the CDs loaded in the 3-CD changer can be registered into the program (i.e., tracks on a CD loaded in the CDR cannot be selected for playback).
- “CD READ DISC” will be shown in the information display as the unit reads the information from each disc.

Note

- To close a tray, press the ▲ button for the tray number that is open. If you press the ▲ button for a tray number other than that for the tray that is open, the program may not be played correctly.

2 Press the PLAY MODE button when the unit is in the CD stop mode.

- The CD PLAYER indicator is shown in the display window, PROGRAM indicator is shown in the display window, and if no program has been registered, “PG NO PROGRAM” is shown in the information display.

Program step number Disc source Track number

PG 501 CD1 1

- If SET is pressed at this time, programming registration will start (Step 3).

3 Press the SET button to start program registration.

- The information display will show the following, and disc source columns will flash.

Programming step number Disc source Track number

PG 501 CD1 1

4 Select the disc source (CD tray) by turning the MULTI JOG control, and then press the SET button.

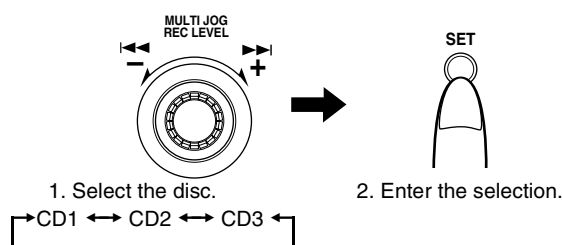

- When the SET button is pressed, next the programming step and track number columns will flash.

5 Select and enter a track number (1-99) by turning the MULTI JOG control, and then press the SET button.

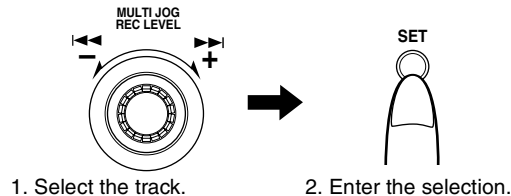

- The following is an example of track 2 on the CD in tray CD1 being entered as Step 1.

PG 501 CD1 2

↓

- When the SET button is pressed, the programming of Step 1 is registered, and programming for Step 2 is ready.

PG 502 CD1 2

6 Repeat Steps 4 and 5 to program up to a maximum of 32 steps.

- If you try to program over 32 steps, “MEMORY FULL” is shown in the information display, and the programming function ends automatically.
- Pressing the CD Control STOP ■ button on the main unit ends the programming function.

7 Press the CD Control PLAY ► button to start programmed play.

- During playback, the disc number, track number and play time of the track are shown in the information display.
- The numbers of the tracks that have been played are cleared from the music calendar. They are displayed again when programmed play is completed.
- Operation stops automatically (and “STOP” is shown in the information display) when all of the programmed tracks have been played.
- If the CD Control PLAY ► button is pressed at a specific step in a program, the programming function will end and playback will start from Step 01, not the step currently shown in the information display.

To clear a step (track) from the program

To erase a programmed track, turn the MULTI JOG Control while in the CD stop mode until the track you want to erase is shown in the information display. Press the CANCEL button to erase the track from the program. The step number for each track following the one erased is automatically reduced by one (i.e., steps are renumbered). To erase the entire program, press the CANCEL button until “PG NO PROGRAM” is shown in the information display.

To change the contents of the program

In the CD stop mode, press the SET button followed by the CANCEL button. Programmed tracks will be erased in the reverse order of when they were entered (starting from the last track programmed). Press the CANCEL button twice to erase one track. Continue erasing in this manner until all of the tracks you wanted to remove are erased. Enter new tracks into the program by following programming Steps 4 and 5.

To check the contents of the program

To check the tracks you have entered into the program, press the CD Control STOP ■ button, and use the MULTI JOG Control to review the programmed tracks. The program steps (PG S**) and track numbers will be shown in the information display one at a time as you toggle through the program (S: Step; **: step number).

To return to continuous playback

In the CD stop mode, repeatedly press the PLAY MODE button on the main unit until the total playing time is shown in the information display.

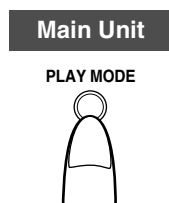

Programming Playback Using the Remote Control

If you want to program and record tracks, see “Program Edit Recording” on page 27.

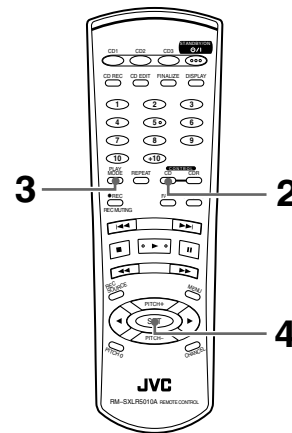

1 Load CDs into the trays of the 3-CD changer.

- Only tracks on the CDs loaded in the 3-CD changer can be registered into the program (i.e., tracks on a CD loaded in the CDR cannot be selected for playback).
- “CD READ DISC” will be shown in the information display as the unit reads the information from each disc.

Note

- To close a tray, press the ▲ button for the tray number that is open. If you press the ▲ button for a tray number other than that for the tray that is open, the program may not be played correctly.

2 Press the CD Deck Selection button to place the unit in the CD mode.

- The CD PLAYER indicator is shown in the display window.

3 Press the PLAY MODE button.

- The PROGRAM indicator is shown in the display window, and if no program has been registered, “PG NO PROGRAM” is shown in the information display.

4 Press the SET button.

- The information display will show the following.

Program step number Disc source Track number
 PG S01 CD1 1

5 Select the disc source (CD tray) using the ◀◀ (reverse) or ▶▶ (forward) buttons, and then press the SET button.

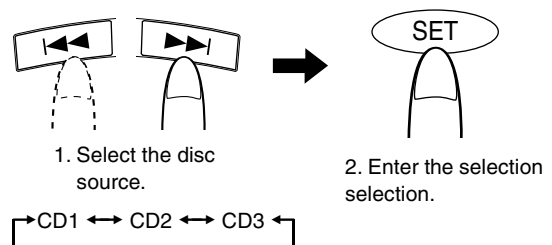

- When the SET button is pressed, next the program step and track number columns will flash.

6 Select and enter a track number (1-99) using the ◀◀ (reverse) or ▶▶ (forward) buttons, and then press the SET button.

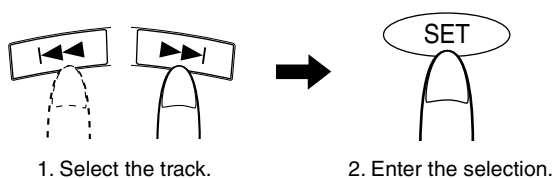

7 Repeat Steps 5 and 6 to program up to a maximum of 32 steps.

- If you try to program over 32 steps, “MEMORY FULL” will be shown in the information display, and the programming function ends automatically.
- Pressing the ■ (stop) button ends the programming function.
- Operation stops automatically when all of the programmed tracks have been played.

8 Press the ▶ button to start program play.

- Operation stops automatically when all the programmed tracks have been played.
- During playback, the disc number, track number and play time of the track are shown in the information display.
- The numbers of the tracks that have been played are cleared from the music calendar. They are displayed again when programmed play is completed.
- Operation stops automatically (and “STOP” is shown in the information display) when all programmed tracks have been played.
- If the ▶ (play) button is pressed at a specific step in a program, the programming function will end and playback will start from Step 01, not the step currently shown in the information display.

To clear a step (track) from the program

To remove a programmed track, while in the CD stop mode, press the ◀◀ (reverse skip) or ▶▶ (forward skip) buttons until the track you want to erase is shown in the information display. Press the CANCEL button to erase the track from the program. The step number for each track following the one erased is automatically reduced by one (i.e., steps are renumbered). To erase the entire program, press the CANCEL button until “PG NO PROGRAM” is shown in the information display.

To change the contents of the program

In the CD stop mode, press the SET button followed by the CANCEL button. Programmed tracks will be erased in the reverse order of when they were entered (starting from the last track programmed). Press the CANCEL button twice to erase one track. Continue erasing in this manner until all of the tracks you wanted to remove are erased. Enter new tracks into the program by following programming Steps 5 and 6.

To check the contents of the program

To check the tracks you have entered into the program, press the ■ (stop) button, and use the ◀◀ (reverse skip) or ▶▶ (forward skip) buttons to review the programmed tracks. The program steps (PG S**) and track numbers will be shown in the information display one at a time as you toggle through the program (S: Step; **: step number).

To return to continuous playback

In the CD stop mode, repeatedly press the PLAY MODE button on the remote control until the total playing time is shown in the information display.

Remote Control



Recording onto CD-R/RW Discs

Notes on Recording

- Do not use CD-R or CD-RW discs with dust and/or scratches on the surface as this may cause the recording to sound rough and may cause skipping when played backed. It may even cause the unit to malfunction.
- When using a recording function (one of the recording indicators in the display window is illuminated), do not subject the unit to any shock or vibration.
- Before recording on a CD-R disc, it is recommended to make a sample recording on a CD-RW disc.
- If the source CD being recorded from the 3-CD changer is itself a first-generation digital copy, digital recording cannot be performed. When this occurs, the recording type will switch from digital to analog automatically, and you should adjust the recording level.

Read through this section before recording.

- Discs not manufactured for holding audio data (such as discs for standard computer use) cannot be recorded using this CDR.
- Discs with a format other than CD-DA (Compact Disc-Digital Audio) cannot be recorded.
- The recording of discs over 80 minutes in length is not supported.
- Multi-session discs cannot be recorded.

Types of recording

The following types of recording are possible with this unit.

Manual recording (see page 21)

Manually control the recording source used and the tracks you want to record. The following is a list of possible settings. (High-speed recording is not possible.)

- DIGITAL (digital recording from external sources connected to the DIGITAL IN OPTICAL terminal or COAXIAL terminal)
- CD (digital/analog recording of CDs loaded in the 3-CD changer)
- LINE (analog recording of external sources connected to the LINE IN terminal)
- MIC (analog recording of input from a microphone connected via the MIC jack)

Synchronized one-button recording of one entire CD (See page 23)

Press the CD REC button while the main unit is in the stop mode to instantly dub the entire selected CD in the 3-CD changer to a CD-R or CD-RW disc. New to this feature is an automatic disc finalization function that can be set before recording begins.

Synchronized one-button recording of a single track (See page 24)

Press the CD REC button while the unit is playing or paused to instantly dub the current track on a CD in the 3-CD changer to a CD-R or CD-RW disc.

Listening Edit recording (see page 26)

Select tracks to be recorded from one or all of the CDs in the 3-CD changer while listening to them. New to this feature is an automatic disc finalization function that can be set before recording begins. (High-speed recording; CD-R 4x, CD-RW 2x)

Program Edit recording (see page 27)

Program tracks to be recorded from one or all of the CDs loaded in the 3-CD changer. New to this feature is an automatic disc finalization function that can be set before recording begins. (High-speed recording; CD-R 4x, CD-RW 2x)

Synchronized recording from external sources (see page 30)

Start recording from an external source as soon as the CDR detects the signal being input. (High-speed recording is not possible.)

Mixed input recording (see page 31)

Simultaneously record the inputs from two analog sources. (Recording level and mixing balance can be adjusted manually.)

Add Finalize Feature

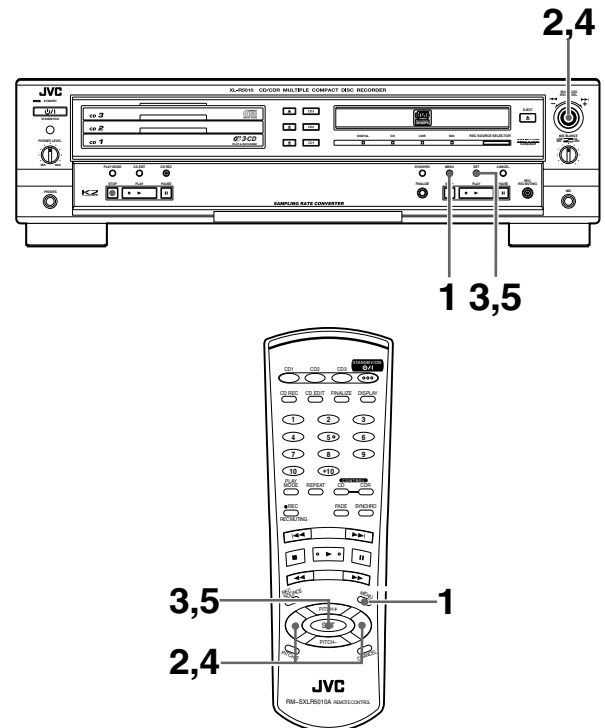

Automatically finalize at the end of a recording onto a CD-R disc when recording the sound from the 3-CD changer using the CD REC button. The Add Finalize feature is enabled at the time of purchase. This feature can also be set to disable finalization at the end of a recording.

To disable the Add Finalize feature

Place the unit in the stop mode and follow the steps below.

1 Press the MENU button.

- "TRACK ERASE" is shown in the information display.

2 Turn the MULTI JOG to display "FINALIZE".

3 Press the SET button.

4 Turn the MULTI JOG to select "OFF".

5 Press the SET button.

Finalization will not be performed upon completion of a recording with the CD REC button.

- To enable the Add Finalize feature, follow the steps 1 through 3 in the above procedure and select "ON" in step 4.

To disable/enable the Add Finalize feature with the remote control

1 Press the MENU button.

2 Press the ◀ or ▶ button to select "FINALIZE".

3 Press the SET button.

4 Press the ◀ or ▶ button to select "OFF" or "ON".

5 Press the SET button.

Analog recording level adjustment

When recording analog signals, and the main unit is recording or stopped in the recording pause mode, after pressing the MENU button on either the main unit or remote control, the recording level can be adjusted using the MULTI JOG control on the main unit. The recording level is shown in the information display as "REC LEVEL - **" (** is a value ranging from -80-0, the default being -12). (Recording level adjustment is not possible when recording using digital signals.)

When CD ANALOG recording is selected, the recording level is set automatically to the CD in the 3-CD changer.

To increase the recording level from LINE IN

When recording the sound from LINE IN, if the recording level is still low after adjustment of the analog recording level stated above, change "LINE IN GAIN" to "HIGH". "LINE IN GAIN" is set to "LOW" at the time of purchase.

Place the unit in the stop mode and follow the steps below.

1 Press the MENU button.

- "TRACK ERASE" is shown in the information display.

2 Turn the MULTI JOG to select "LINE IN GAIN".

3 Press the SET button.

- "LOW" is shown in the information display.

4 Turn the MULTI JOG to select "HIGH".

5 Press the SET button.

- The recording level further increases.
- - To change "LINE IN GAIN" back to "HIGH", follow steps 1 through 3 in the above procedure and select "LOW" in step 4.

To increase the recording level with the remote control

1 Press the MENU button.

2 Press the ◀ or ▶ button to select "LINE IN GAIN".

3 Press the SET button.

4 Press the ◀ or ▶ button to select "HIGH".

5 Press the SET button.

Sampling rate converter

The main unit is equipped with a sampling rate converter to ensure that the original digital signals will be recorded regardless of the sampling frequency (32kHz, 44.1kHz or 48kHz) of the signal from the source.

Microphone connections

Use a microphone equipped with a standard plug to connect to the MIC jack on this unit.

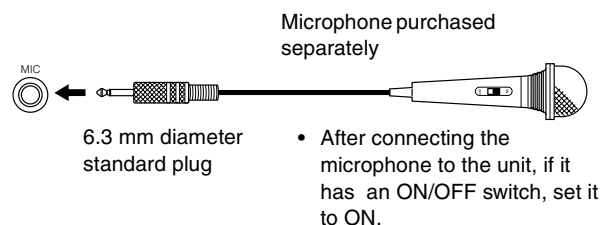

Manual Recording

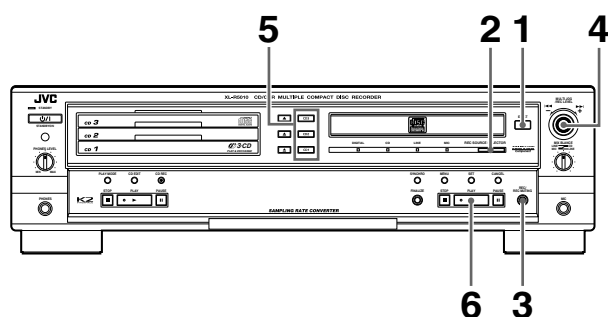

1 Insert a recordable CD-R or CD-RW.

2 Select a recording source.

Use the REC SOURCE SELECTOR button to select the recording source. Press the button repeatedly to toggle between sources. The source type will appear in the display window, and a lamp (DIGITAL, CD, LINE or MIC) will light on the front panel showing the selected source. The order of toggling and appearance of the sources in the information display (starting from DIGITAL IN) are as follows.

DIGITAL IN:	Record digital signals via the OPTICAL terminal.
COAXIAL IN:	Record via the COAXIAL terminal.
CD DIGITAL:	Record digital signals from 3-CD changer.
CD ANALOG*:	Record analog signals from 3-CD changer.
LINE IN:	Record via the LINE IN terminal.
MIC IN:	Record via the MIC jack.
CD+LINE MIX**:	Record via 3-CD changer and LINE mix.
CD+MIC MIX**:	Record via 3-CD changer and MIC mix.
LINE+MIC MIX**:	Record via LINE and MIC mix.

Notes

- *In accordance with the SCMS (Serial Copy Management System), recording systems are not allowed to create a second-generation digital copy of a first generation copy (refer to SCMS see page 46). Therefore, if a CD-R or CD-RW disc loaded in the 3-CD changer is a first-generation digital copy, this recording selection must be used. If you attempt to record the disc using the digital setting, "SCMS PROTECT" is shown in the information display and recording will not be allowed. (To be continued on the next page)

- ** MIX (combined) source recording is only possible in analog.
- If a source has already been selected, the corresponding lamp will light and the selection will be shown in the display window.
- When playback is stopped and the CDR is selected, press the DISPLAY button on the remote control repeatedly to show the recording time remaining on the disc.
- High-speed recording is not possible when recording manually.

3 Press ●REC/REC MUTING to put the CDR in recording pause mode.

- The disc is read and OPC performed if required.
- The remaining recording time on the CD-R or CD-RW disc is shown in the information display.

4 When analog signals are to be recorded, adjust the recording level.

- Press the MENU button first and turn the MULTI JOG to adjust the recording level. Then press the SET button.
- Adjust the volume in such a way that the 0 dB display is not exceeded when the loudest sound is applied.

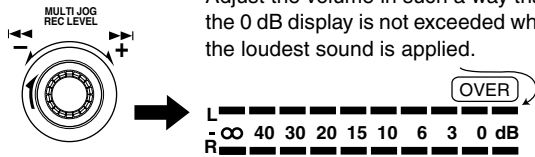

The OVER indicator should not be made to light as this may cause distortion in the recording.

- When CD ANALOG recording is selected, the recording level is set automatically to the CD in the 3-CD changer.

5 Play the sound of the source to be recorded.

6 Press the CDR Control PLAY ► button to start recording.

When recording is complete

Press the CDR Control STOP ■ button to stop, the ► indicator in the display window flashes and operation stops.

Notes

- You cannot record from multiple CDs. If create a program that changes CDs, a blank track of a few seconds will be added and recording will stop.
- When "UNLOCK" is shown in the information display, the DIGITAL IN terminal is not connected properly to the source unit.
- Upon completion of recording, the ► indicator flashes in the display window. Operating any button while this indicator is flashing may render the disc being recorded unusable. Always wait until the ► indicator stops flashing before proceeding with the next operation.
- When digital input signals are supplied, they will be recorded in their original digital form as long as the source signal is not from a first-generation digital copy (refer to SCMS on see page 46). There is no need to adjust the recording level.

To record silence in the recording

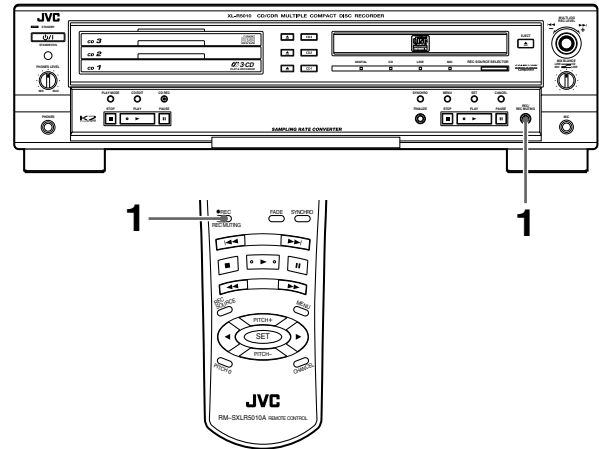

1 Press the ●REC/REC MUTING button where you want record a four-second silence.

- To record a silence longer than four seconds, keep pressing the ●REC/REC MUTING button as long as you want.

Notes

- Four seconds of silence will be recorded regardless of whether or not the button is held down for fewer or more than four seconds. After the four seconds of silence, the unit stops in the recording pause mode after the button is released.
- The REC MUTING function cannot be used at the beginning of recording started from the recording pause mode

Fade In/Fade Out Recording (analog only)

This feature can be used to record analog sound other than CD ANALOG.

Located immediately below the CONTROL CD button on the remote control is a special button (FADE) that allows you to perform fade in and fade out of sound at the beginning and end of tracks when you are recording analog signals. To fade in at the beginning of a track, put the CDR into the recording pause mode and press the FADE button to start recording. To fade out at the end of a track, press the FADE button during the recording process. The signal will fade out and the CDR will stop in the recording pause mode.

- This function cannot be used when recording digital signals.

Automatic and manual track marking

A track mark specifies the end of one track and the beginning of another. The unit inserts track marks automatically when the AUTO TRACK function is turned on, or you can turn off the function and insert them manually.

AUTO TRACK function on

- Tracks are automatically marked in the recording. For digital sources, the track information recorded in the digital source signal is used. For analog recording, periods of silence (no audio input from the recording source) are interpreted as track separations and a track mark is inserted.

AUTO TRACK function off

- Manual track marking offers you the flexibility of placing track marks anywhere you like in the recording.
- Manual track marking is not possible when the AUTO TRACK function is on.

To add track marks automatically

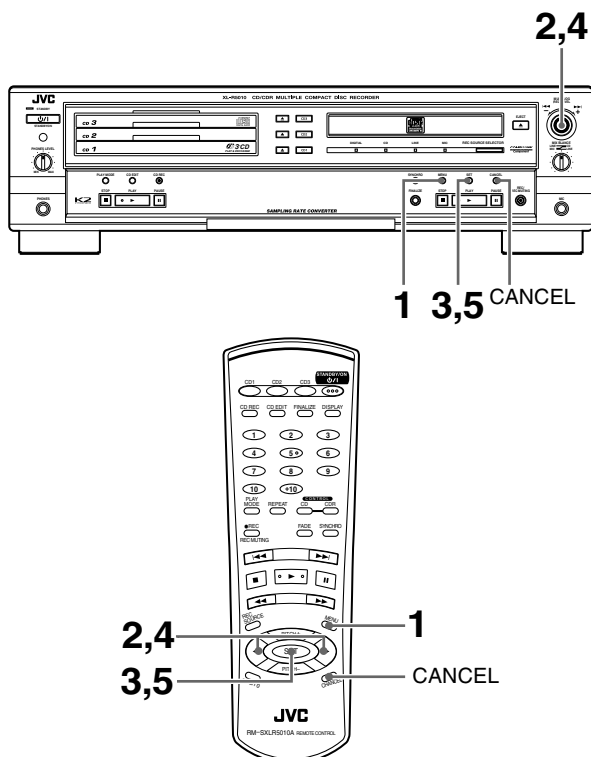

- 1 When the unit is in the stop mode, press the MENU button (main unit/remote control).
- 2 Turn the MULTI JOG control or press the ◀/▶ (menu) button on the remote control until "AUTO TRACK" is shown in the information display.
- 3 Press the SET button (main unit/remote control).
- 4 Turn the MULTI JOG control or press the ◀/▶ (menu) button on the remote control to select "AUTO TR ON".
 - "ON" will flash in the information display. (The default setting for this function is on.)
- 5 Press the SET button (main unit/remote control).
 - The AUTO TRACK indicator is now shown in the display window.
 - Press the CANCEL button (main unit/remote control) to cancel the procedure and return to the normal display.

Note

In order to prevent the beginning of a song from being cutoff when changing tracks, digital sources provide a safety variance of 12 frames and analog sources 19 frames.

To add track marks manually

- 1 Follow the procedure written for selecting the AUTO TRACK function, but in Step 4, select AUTO TR OFF.
- 2 Press the Set button (main unit/remote control).
 - The AUTO TRACK indicator in the display window will turn off.
 - Press the CANCEL button (main unit/remote control) to cancel the procedure and return to the normal display.
- 3 During recording, press the SET button (main unit/remote control) to insert a track mark.

Notes

- Even if automatic track marking is turned off, automatic track marking will be performed during synchronized one-button recording. When this occurs, manual track marking is temporarily disabled.
- Tracks must be at least four seconds in length. Pressing the SET button less than four seconds after the previous track mark creates a new track mark once 4 seconds of recording has been performed.

Synchronized Recording of 3-CD Changer Playback

Performing synchronized one-button recording of one entire CD

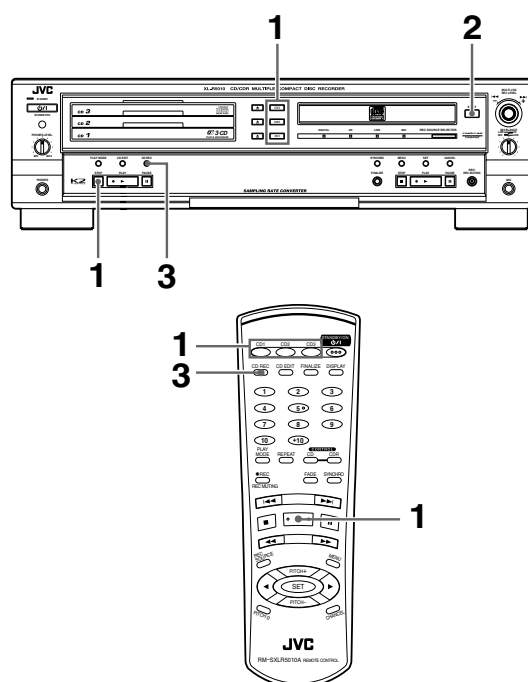

Note

- It is only possible to record from a CD loaded in the 3-CD changer using this feature.
(To be continued on the next page)

1 Select and stop the CD to be recorded.

Example: To record the CD loaded in tray CD1.

- Only the selected CD is recorded.

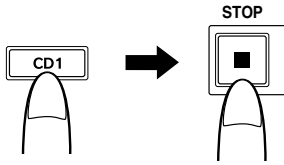

2 Load a recordable CD-R or CD-RW disc into the CDR and close the tray.

- The disc is read if required.

3 Press the CD REC button (main unit/remote control) to start recording. "DISC DUBBING" is shown in the information display

- When a blank disc is in the CDR tray, "UPDATE OPC" is shown following "DISC DUBBING".

When "ADD FINALIZE?" is shown in the information window:

- No response (no input) assumes that finalization is to be performed, or you can press the SET button (main unit/remote control) to confirm that finalization is to be done. Press the CANCEL button (main unit/remote control) to keep the disc unfinalized.

Note

- This message will not be shown if the menu FINALIZE function setting is "OFF". The default setting is "ON".

The 3-CD changer and CDR start simultaneously. (This is called synchronized recording)

- Recording starts from the first track of the CD.

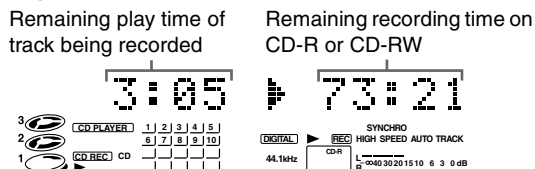

- When a digital CD is recorded, its signals are recorded in their original form. Track marks are inserted automatically where one track changes to the next and track numbers change accordingly.

When the recording of the last song in the CD is complete, "STOP DUBBING" flashes and recording automatically stops.

When recorded without canceling "ADD FINALIZE?"

"FINALIZE" is shown in the information window after recording is stopped and finalization is automatically performed.

Checking a track number during recording

Press the DISPLAY button on the remote control.

Remote Control

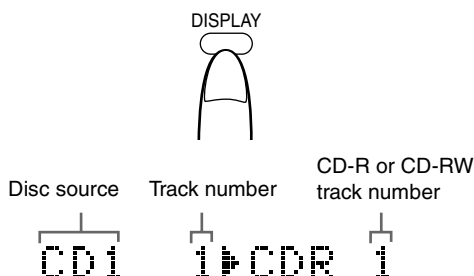

To stop the recording at any time

Press the CDR or CD Control STOP ■ button on the main unit or the ■ (stop) button on the remote control. "STOP DUBBING" flashes in the information display, and the unit stops recording.

Notes

- There is no need to adjust the recording level when recording a digital signal.
- If the source CD being recorded from the 3-CD changer is itself a first-generation digital copy, digital recording cannot be performed. When this occurs, the recording type will switch from digital to analog automatically.
- This type of recording cannot be started during CD playback. It must start from the beginning of the first track of the CD.
- When the CD REC button is pressed, the function is automatically switched to CD. This means that when the CD to be recorded has been selected, recording can proceed straightaway.
- Upon completion of recording, "STOP DUBBING" flashes in the information display. Always wait for the "STOP DUBBING" message to be cleared before proceeding with the next operation.
- When you try to eject the disc from the CDR tray, "FINALIZE?" is shown in the information display when recording onto an unfinalized disc. To finalize the disc, press either the SET or FINALIZE button (main unit/remote control). To skip the finalization process, press the EJECT ▲ button one more time or the CANCEL button (main unit/remote control).
- Depending on the disc, the entire CD may not be recorded. In such a case, use the 1 Disc Dubbing feature (see page 25) to record.

Performing synchronized one-button recording of a single track

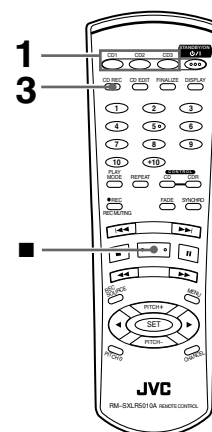
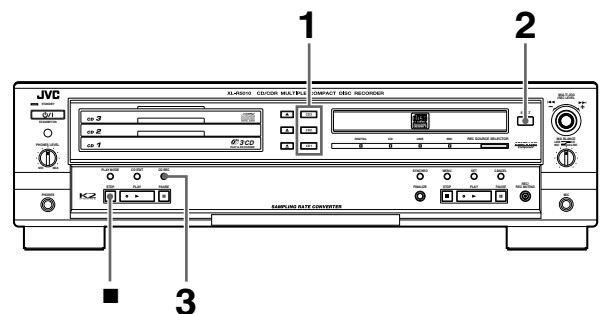

1 Select a disc and start playback.

Example: When planning to record a track on CD1

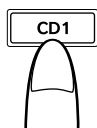

2 Insert a recordable CD-R or CD-RW disc in the CDR disc tray.

- The disc is read.

3 While the disc is playing back the track you want to record or if that track is being paused, press CD REC (main unit/remote control).

Main Unit



Remote Control



“1TR DUBBING” is shown in the information display.

- When a blank disk is in the CDR tray, “UPDATE OPC” is shown following “1TR DUBBING”.

When “ADD FINALIZE?” is shown in the information window:

- No response (no input) assumes that finalization is to be performed, or you can press the SET button (main unit/remote control) to confirm that finalization is to be done. Press the CANCEL button (main unit/remote control) to keep the disc unfinalized.

Note

- This message will not be shown if the menu FINALIZE function setting is “OFF”. The default setting is “ON”.

The CD restarts playback from the beginning of the track and the CDR starts recording simultaneously.

- When a track is recorded, its digital signals are recorded in their original form. A new track mark is automatically placed at the beginning of the track being recorded.

When recording completes

“STOP DUBBING” flashes and recording automatically stops.

When recorded without canceling “ADD FINALIZE?”

“FINALIZE” is shown in the information window after recording is stopped and finalization is automatically performed.

To stop recording at any time

Press the CD or CDR STOP ■ button on the main unit or the ■ (stop) button on the remote control to end recording. The recording mode is released after “STOP DUBBING” is shown in the information display.

Notes

- There is no need to adjust the recording level when recording a digital signal.
- If the source CD being recorded from the 3-CD changer is itself a first-generation digital copy, digital recording cannot be performed. When this occurs, the recording type will switch from digital to analog automatically.

- Upon completion of recording, “STOP DUBBING” is shown in the information display. Always wait for the “STOP DUBBING” message to be cleared before proceeding with the next operation.

1 Disc Dubbing

- You can make a complete copy of a CD that you want to record onto a CD-R/CD-RW disc. When recording a CD with song numbers but no silence between songs such as a live CD, for example, you can use the 1 DISC DUBBING feature to make a recording without any silence.

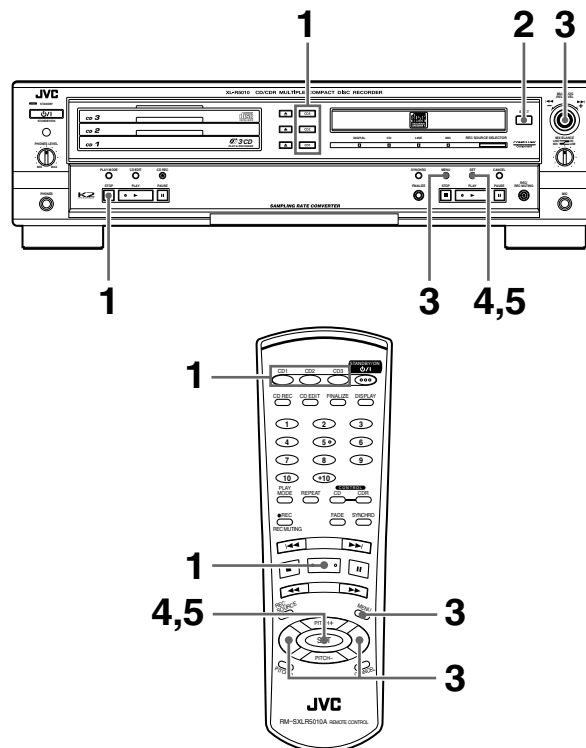

1 Select and stop the CD to be recorded.

Example: To record the CD loaded in tray CD1.

- Only the selected CD is recorded.

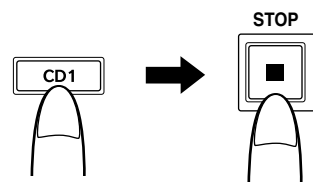

2 Load a recordable CD-R or CD-RW disc into the CDR and close the tray.

- The disc is read.

3 Press the MENU button (main unit/remote control), and then turn the MULTI JOG control on the main unit or press the ◀ or ▶ button on the remote control until “1 DISC DUBBING” is shown in the information display.

4 Press the SET button.

“DUBBING READY?” is shown in the information display.

- Only the selected CD is recorded.

5 Press the SET button.

(To be continued on the next page)

“DISC DUBBING?” is shown in the information display.

- When a blank disc is in the CDR tray, “UPDATE OPC” is shown following “DISC DUBBING”.

The 3-CD changer and CDR start simultaneously.

- Recording starts from the first track of the CD.

When recording completes, “STOP DUBBING” flashes and recording automatically stops.

Notes

- Recording can only start if the total time of the tracks on the source disc is less than the time remaining on the disc being recorded to. If the track time on the source disc is longer, the message “SHORT REMAIN” is shown in the information display and the dubbing function is ended.
- If a track on the source disc is of SCMS format, the message “SCMS PROTECT” is shown in the information display, and the dubbing function is ended.
- Do not finalize the disc.

Listening Edit Recording

Selected tracks can be programmed and recorded.

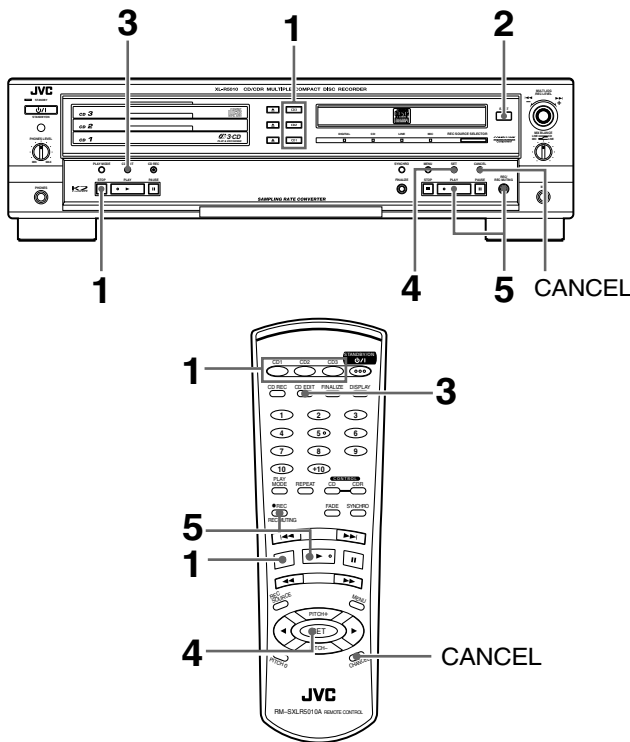

- 1 Select and stop the CD to be recorded.**
- 2 Load a recordable CD-R or CD-RW in the CDR tray.**
 - The disc is read.
- 3 Press the CD EDIT button (main unit/remote control) to select the Listening Edit mode.**

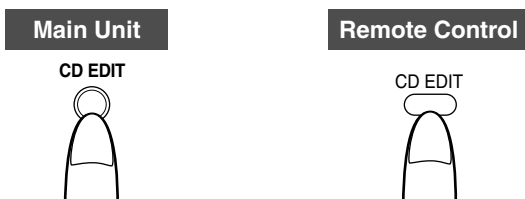

“LISTEN EDIT” is shown in the information display for 3 seconds, the LISTENING EDIT edit recording indicator is shown in the display window.

- The CD trays of the 3-CD changer cannot be opened once the listening edit mode is activated.
- If tracks have already been programmed for the CDs, “LAST L-PG OK?” is shown in the information display. Press the SET button on either the remote control or the main unit or press the PLAY button on the main unit to record the same programmed tracks.

Recording starts.

To program new tracks, press the CANCEL button and then proceed to step 4.

4 Program the tracks while the CD is playing by assigning a tag to each track on the disc.

- This is done by pressing either the SET button (main unit/remote control) to add the track to the program or the CANCEL button (main unit/remote control) to skip the track.
 - When the track now playing is to be recorded

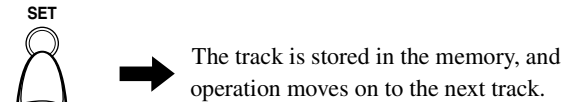

- When the track is not to be recorded

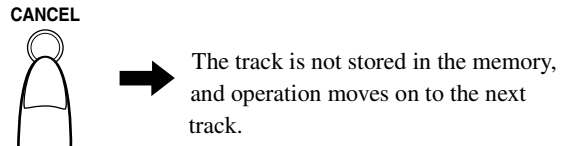

When the first track has been stored in memory

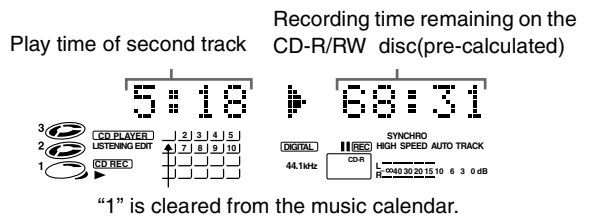

After making the last programming choice, “START TO DUB?” is shown in the information display. Press the SET button (main unit/remote control) to continue or the CANCEL button (main unit/remote control) to end the function.

Note

- Up to 32 steps can be included in the programming. The same track cannot be programmed twice. When there is not much recording time left on the CD-R or CD-RW disc, tracks that are longer than the remaining time (pre-calculated) can be programmed but “NO REM” is shown in the information display.

5 Press the CDR Control PLAY ► or ● REC/REC MUTING button on the main unit or the ► (play) or ● REC/REC MUTING button on the remote control. Recording of the selected songs will begin.

“START TO DUB?” is shown in the information display

When "ADD FINALIZE?" is shown in the information window:

- No response (no input) assumes that finalization is to be performed, or you can press the SET button (main unit/remote control) to confirm that finalization is to be done. Press the CANCEL button (main unit/remote control) to keep the disc unfinalized.

Note

- This message will not be shown if the menu FINALIZE function setting is "OFF". The default setting is "ON".
- When a blank disc is in the CDR tray, "UPDATE OPC" is shown following "ADD FINALIZE?".

The recording process starts.

- Only the tracks selected from the CDs in the 3-CD changer are recorded.
- Playback starts from the first track selected. The playing time of the track and the remaining playing time of the CD-R or CD-RW disc are shown in the information display.
- As high-speed recording is performed (CD-R 4x, CD-RW 2x), there is no audio output during the recording process.

When recording completes

"STOP DUBBING" flashes and recording automatically stops.

When recorded without canceling "ADD FINALIZE?"

"FINALIZE" is shown in the information window after recording is stopped and finalization is automatically performed.

To stop the recording at any time

Press the CD Control STOP ■, CDR Control STOP ■ or CANCEL button on the main unit or the ■ (stop) or CANCEL button on the remote control to stop the recording process. The recording mode is released after "STOP DUBBING" is shown in the information display.

Notes

- There is no need to adjust the recording level when recording a digital signal.
- The last program information (the most recently created program still stored in the unit's memory) will be erased if the trays of the 3-CD changer are opened.

Program Edit Recording

This type of recording allows you to make a program of your favorite tracks on any of the CDs loaded in the 3-CD changer in any order you like.

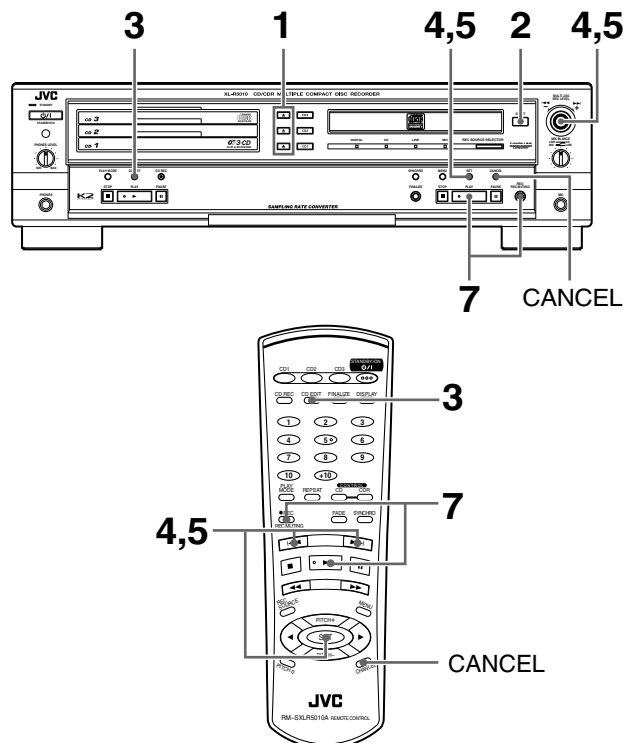

1 Load CDs in the 3-CD changer

Note

- To close a tray, press the ▲ button for the tray number that is open. If you press the ▲ button for a tray number other than that for the tray that is open, the program may not be played correctly.

2 Load a recordable CD-R or CD-RW disc in the CDR tray.

- The disc is read.

3 Press the CD EDIT button (main unit/remote control) twice to select the Program Edit mode.

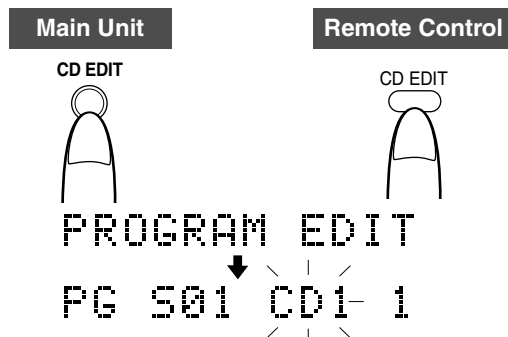

- The unit may be required to read the TOC (Table of Contents) of the CDs loaded in the 3-CD changer. If this is done, "TOC READING" is shown in the information display. (To be continued on the next page)

If tracks have already been programmed for the CDs, "LAST P-PG OK?" is shown in the information display. Press the SET button on either the remote control or the main unit or press the PLAY button on the main unit to record the same programmed tracks.

Recording starts.

To program new tracks, press the CANCEL button and then proceed to step 4.

- If you press the CANCEL button, the playing time remaining time on the CD-R or CD-RW disc in the CDR is shown in the information display.

4 Select and enter the disc number.

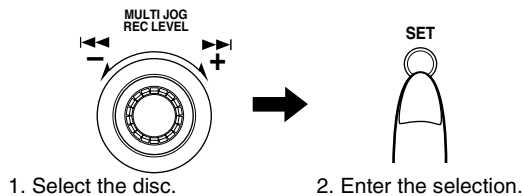

- The disc source can be selected using the MULTI JOG control on the main unit or the ◀▶ buttons on the remote control.
- When the SET button (main unit/remote control) is pressed, the programming and track numbers shown in the information display start flashing.

5 Select and enter a track number.

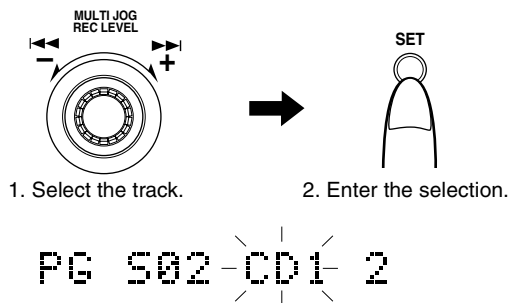

- After the track is entered, the amount of time remaining on the CD-R or CD-RW disc is shown in the information display.

6 Repeat Steps 4 and 5 to continue programming tracks.

- Up to 32 steps can be programmed. The same track may be programmed more than once.
- Programming ends when 32 steps have been registered or if there is no more time remaining on the CD-R or CD-RW.

7 Press the CDR Control PLAY ► or ● REC/REC MUTING button on the main unit or the ► (play) or ● REC/REC MUTING button on the remote control.

When "ADD FINALIZE?" is shown in the information window:

- No response (no input) assumes that finalization is to be performed, or you can press the SET button (main unit/remote control) to confirm that finalization is to be done. Press the CANCEL button (main unit/remote control) to keep the disc unfinalized.

Note

- This message will not be shown if the menu FINALIZE function setting is "OFF". The default setting is "ON".

When a blank disc is in the CDR tray, "UPDATE OPC" is shown following "ADD FINALIZE?".

The recording process starts.

- Only the tracks selected from the CDs in the 3-CD changer are recorded.
- Playback starts from the first track selected. The playing time of the track and the remaining playing time of the CD-R or CD-RW disc are shown in the information display.
- As high-speed recording is performed (CD-R 4x, CD-RW 2x), there is no audio output during the recording process.

When recording completes

"STOP DUBBING" flashes and recording automatically stops.

When recorded without canceling "ADD FINALIZE?"

"FINALIZE" is shown in the information window after recording is stopped and finalization is automatically performed.

To stop the recording at any time

Press the CD Control STOP ■, CDR Control STOP ■ or CANCEL button on the main unit or the ■ (stop) or CANCEL button on the remote control to stop the recording process. The recording mode is released after "STOP DUBBING" is shown in the information display.

3-CD Changer to CDR Recording Options

- There are a number of advantages of having a 3-CD changer and CDR in the same unit, mainly that the unit has direct control over both components. Because of this, the following recording options are available: normal dubbing, high-speed dubbing (4x for CD-R and 2x for CD-RW discs) and track spacing.

Setting the Unit for High-speed Recording

High-speed recording is only possible for digital recording from the 3-CD changer to the CDR.

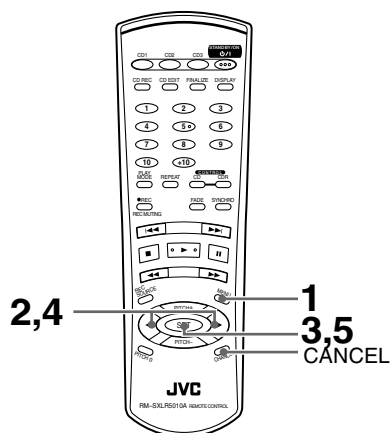
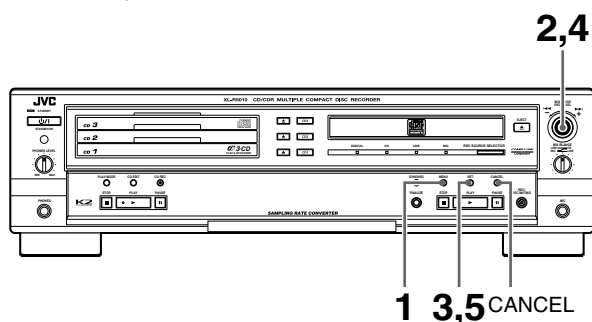

- 1** When the unit is in the stop mode, press the **MENU** button (main unit/remote control).
- 2** Turn the **MULTI JOG** control or press the **◀/▶** (menu) button on the remote control until “**DUB-SPEED**” is shown in the information display.
- 3** Press the **SET** button (main unit/remote control).
 - The current setting is shown in the display window. (The setting is **HIGH** by default.)
 - The speed for recording to CD-R discs is four times the normal recording speed, and that for recording to CD-RW discs is two times the normal recording speed.
- 4** Turn the **MULTI JOG** control or press the **◀/▶** (menu) button on the remote control to select “**HIGH**” or “**1x**”.
 - If “**HIGH**” is selected, “**HIGH**” flashes in the display window.
 - Press the **CANCEL** button (main unit/remote control) to cancel the procedure and return to the normal display.
- 5** Press the **SET** button.

Notes

High-speed recording is only possible for digital recording from the 3-CD changer to the CDR. It can be used for 1-track dubbing, 1-disc dubbing, listening edit and program edit modes.

- There is no audio output from any of the output terminals (**LINE OUT**, **DIGITAL OUT OPTICAL**, **DIGITAL OUT**, **COAXIAL**, **PHONES**) during high-speed recording. Therefore, the only way to monitor the process is using the recording level meter in the display window.

Setting the Auto Track Spacing Function

When the automatic track spacing function is turned on, the unit automatically records 2 seconds of silence at the beginning of each track when performing synchronized one-button recording or using the listening edit or program edit modes to record from the 3-CD changer to the CDR.

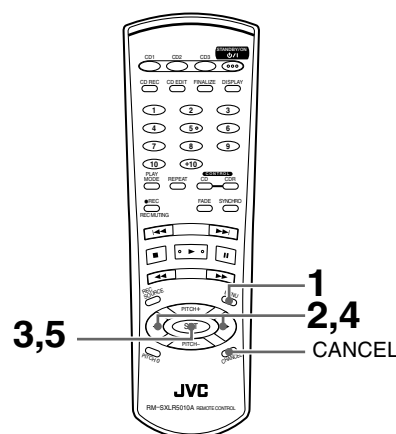
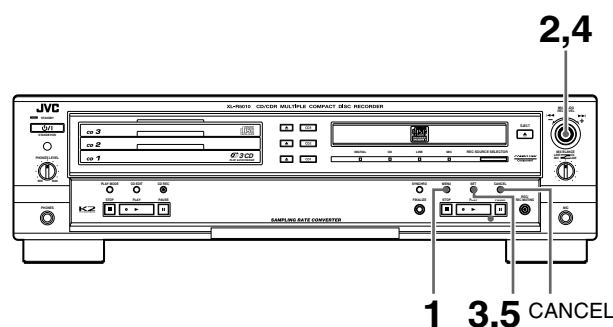

- 1** When the unit is in the stop mode, press the **MENU** button (main unit/remote control).
 - 2** Turn the **MULTI JOG** control or press the **◀/▶** (menu) button on the remote control until “**TRACK SPACE**” is shown in the information display.
 - 3** Press the **SET** button (main unit/remote control).
 - The current setting is displayed on the screen. (The setting is on by default.)
- (To be continued on the next page)*

4 Turn the MULTI JOG control or press the ◀▶ (menu) button on the remote control and choose the setting “TR SPACE ON” or “TR SPACE OFF”.

- Press the CANCEL button (main unit/remote control) to cancel the procedure and return to the normal display.

5 Press the SET button.

Notes

- There is no indicator to show the status of this function.
- This function will work when you begin recording from the recording pause mode except when performing synchronized one-button recording.

Synchronized Recording from External Sources

This unit offers the ability to record from various external sources to the CDR using synchronized START and START&STOP functions. This feature is applicable to external digital audio equipment connected via the DIGITAL IN OPTICAL and COAXIAL terminals and the LINE IN (REC) terminal.

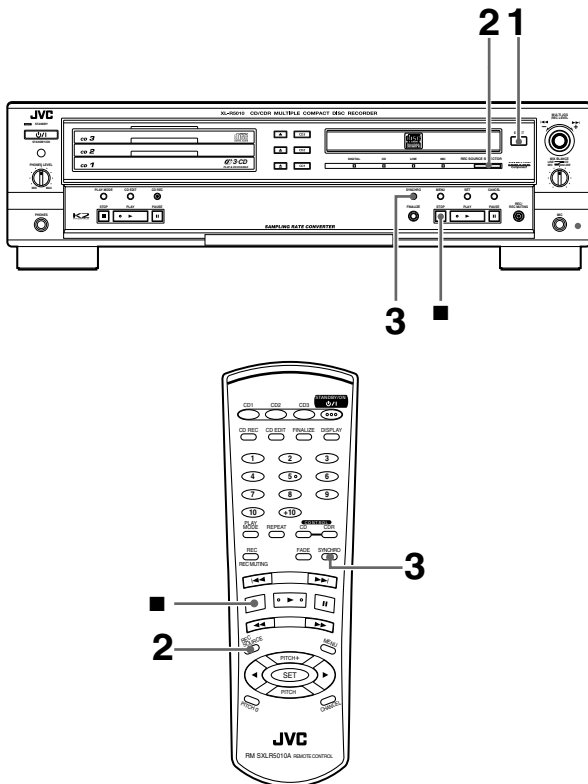

- Synchronized recording to the CDR from an external source.

1 Load a recordable CD-R or CD-RW disc in the CDR tray.

- The disc is read if required.

2 Press the REC SOURCE SELECTOR button on the main unit or the REC SOURCE button on the remote control repeatedly to select the recording source.

- Each press of the selection button on either the main unit or remote control, toggles one step through the following source choices.

DIGITAL IN: Record digital signals via the OPTICAL terminal.

COAXIAL IN: Record via the COAXIAL terminal.

CD DIGITAL: Record digital signals from 3-CD changer.

CD ANALOG: Record analog signals from 3-CD changer.

LINE IN: Record via the LINE IN terminal.

MIC IN: Record via the MIC jack.

CD+LINE MIX: Record via 3-CD changer and LINE mix.

CD+MIC MIX: Record via 3-CD changer and MIC mix.

LINE+MIC MIX: Record via LINE and MIC mix.

- Press REC SOURCE SELECTOR on the main unit or REC SOURCE button on the remote control to choose the proper terminal connection for the source to be recorded from (DIGITAL IN, COAXIAL IN or LINE IN).

- If DIGITAL IN or COAXIAL IN is selected, the LED lamp under DIGITAL IN selection to the left of the REC SOURCE SELECTOR will light.

3 Press the SYNCHRO button (main unit/remote control).

- The CDR is put into the synchronized recording pause mode.
- The source device must be stopped (cannot be playing) at this time.

4 Start playing of the source unit

Note

- When recording with the SYNCHRO button, recording starts when the input level is detected. If the track starts very quietly (with a low input level), the beginning of the track may not be recorded. When recording from an analog source, such as records or tapes, recording may not start if the recording level is too low. When this occurs, please perform manual recording.

Performing synchronized recording of a digital source

- Recording is started based on the digital signal.
- Track marking is based on track information recorded in the digital signal. For digital sources other than CD, MD and DAT, track marking is based on silent track space.

Performing synchronized recording of an analog source

- Recording is started when the unit detects an audio signal.
- Track marking is based on silent track space which the unit interprets to be track breaks. If automatic track marking has been turned off, manual track marking is necessary during the recording process.

To stop recording at any time

Press the CDR Control STOP ■ button on the main unit or the ■ (stop) button on the remote control.

Setting the START or START&STOP function for synchronized recording from an external source

If the signal is going to be recorded from CD, MD or DAT player, it is possible to set the unit to perform synchronized start and stop. This only applies for recording sources that are connected to the DIGITAL IN (DIGITAL IN OPTICAL) terminal. With other types of digital audio equipment only synchronized start of recording is possible.

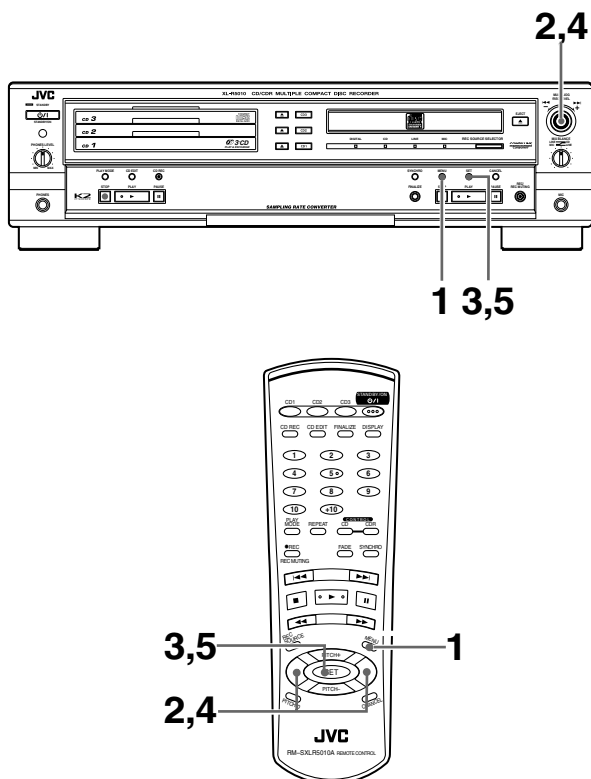

- 1** With the unit in the stop mode, press the MENU button (main unit/remote control).
- 2** Turn the MULTI JOG control or press the ◀▶ (menu) button on the remote control until “D-IN SYNCHRO” is shown in the information display.
- 3** Press the SET button (main unit/remote control).
 - The current setting is shown in the information display.
- 4** Turn the MULTI JOG control or press the ◀▶ (menu) button on the remote control to select “START” or “START&STOP”, shown in the information display.
 - When “START” is selected, only the start of recording is done synchronously with the start of the digital signal.
 - Press the CANCEL button if you do not want to perform this procedure. The setting is not changed.
- 5** Press the SET button.
 - The type of synchronized recording being performed is not indicated in the information display during actual recording. When recording is started, only the SYNCHRO indicator is shown in the display window until recording ends.

- If the setting is set to “START&STOP”, recording stops automatically when the signal from the source is stopped, a disc is changed, or if a track search is performed.
- This function is very convenient for recording single songs from external digital CD or MD players.
- This function is only for use with externally connected digital audio equipment. It cannot be used with the 3-CD changer.

CAUTION

When performing synchronized start recording from an external component, it is possible that part of the signal at the beginning of the first track will not be recorded. If this should occur, please perform manual recording.

Mixed Input Recording

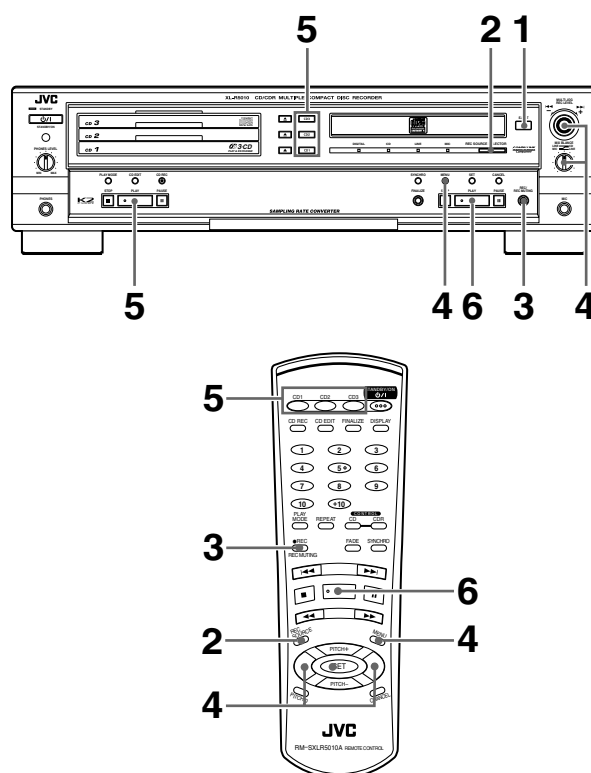

- 1** Load a recordable CD-R or CD-RW in the CDR disc tray.
 - The disc is read.
- 2** Press the REC SOURCE SELECTOR button on the main unit or the REC SOURCE button on the remote control to select the recording source combination.

Example

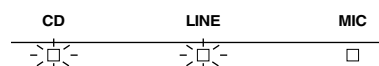

CD + LINE has been selected.

(To be continued on the next page)

- Select “CD + LINE” to mix and record a CD loaded in the 3-CD changer with the signals from an external source via the LINE IN terminal.
- Select “CD + MIC” to mix and record a CD loaded in the 3-CD changer with the signals from a microphone plugged into the MIC jack.
- Select “LINE + MIC” to mix and record the signals from an external source connected via the LINE IN terminal and those from a microphone plugged into the MIC jack.

3 Press the ● REC/REC MUTING button (main unit/remote control) to put the CDR in the recording pause mode.

- The remaining recording time on the disc is shown in the information display.

4 Press the MENU button (main unit/remote control) and select the sources for setting the recording level. Use the MULTI JOG/REC LEVEL and MIX BALANCE controls to adjust the recording level and mixing balance while playing the two sources. .

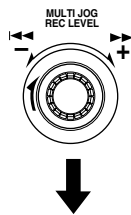

CD + LINE	CD recording level is reduced.	Line input recording level is reduced.
CD + MIC	CD recording level is reduced.	MIC input recording level is reduced.
LINE + MIC	Line input recording level is reduced.	MIC input recording level is reduced.

- Adjust the recording level so that the 0 dB display of the level meter is not exceeded when the highest signal is applied.
- If the CD input is selected for mixed recording, the pitch controls may be used to adjust the speed of CD playback for mixing and recording purposes.
- If the microphone level is set too high, a loud howling sound may be emitted from the speakers. If this occurs, turn down the volume of the microphone by turning down the volume of the amplifier/receiver powering the speakers you are using to monitor the sound.
- When you have finished adjusting the recording level and the mix balance, set the sources back to the point where you want to start recording from.

5 Start playback of the sources to be recorded.

6 Press the CDR Control PLAY ► button on the main unit or the ► (play) button on the remote control to start recording.

To stop recording at any time

Press the CDR Control STOP ■ button on the main unit or the ■ (stop) button on the remote control. The Play ► indicator in the display window will flash and operation stops.

Special Recording Edit Operations

Skipping a Recorded Track on a CD-R or CD-RW (Track Skip)

Occasionally, there may be tracks on a disc that are partial, repeated, or are otherwise unwanted. Before a CD-R or CD-RW is finalized, it is possible to enter a skip marker for that track in the PMA (Program Memory Area). A maximum of 21 skip marks can be inserted on one disc. When a disc is finalized, the information of tracks assigned a skip mark is written to the disc's TOC (Table of Contents) and those tracks will never be played (i.e., just as if they had never been recorded.)

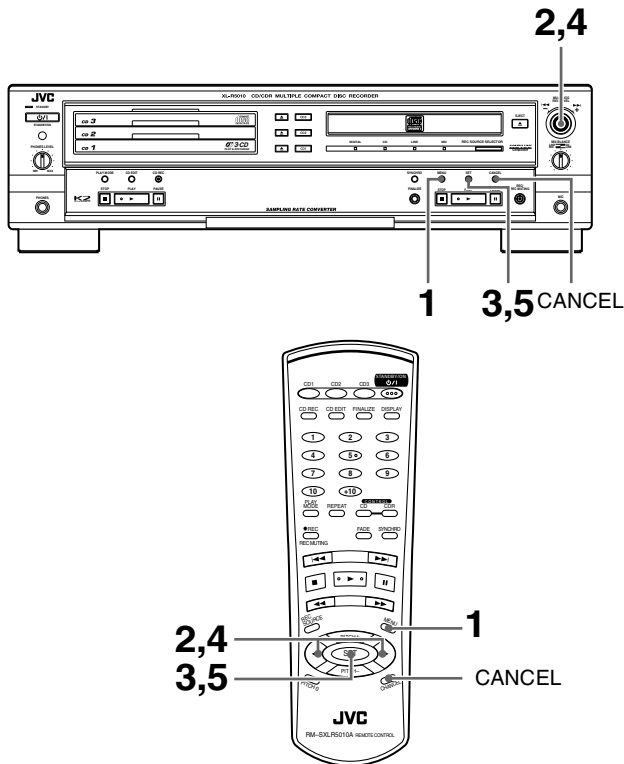

Caution

Once a skip marker has been entered for a track, it cannot be removed.

- 1** When the unit is in the stop mode, press the **MENU** button (main unit/remote control).
- 2** Turn the **MULTI JOG** control or press the **◀** (menu) button on the remote control until "TRACK SKIP" is shown in the information display.
- 3** Press the **SET** button (main unit/remote control).
 - "SKIP (track number)?" is shown in the information display.
 - Press the **CANCEL** button (main unit/remote control) if you do not wish to perform this procedure.
- 4** Turn the **MULTI JOG** control or press the **◀/▶** (menu) button on the remote control to select the track number to be skipped.

5 Press the Set button (main unit/remote control).

- A skip marker is entered into the PMA for the selected track and **WRITE SKIP** is shown in the information display. When the process is finished, the normal display is shown.
- The track to be skipped is cleared from the music calendar.

Notes

- Even if a track is skipped, the recorded information is not erased and the time remaining on the CD-R or CD-RW does not change.
- Tracks that have been assigned a skip marker are only skipped during playback on this unit and other CD players that support the track skip function.
- You cannot use the track skip function when recording to unfinalized CD-R discs or CD-RW discs from the 3-CD changer.

Erasing a Track or Tracks (Erase Function) (CD-RW only)

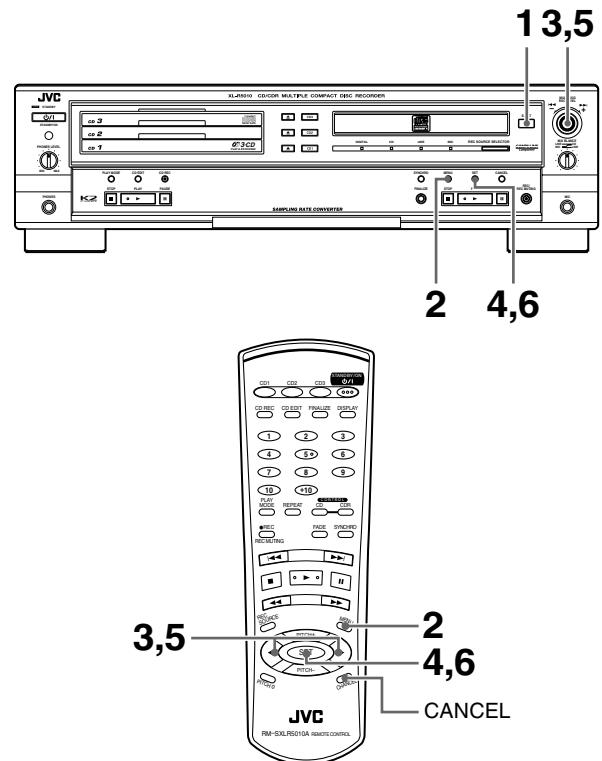

- 1** Load the unfinalized CD-RW to be edited in the CDR disc tray.
 - The number of tracks and play time are shown in the information display.
- 2** When the unit is in the stop mode, press the **MENU** button (main unit/remote control).
- 3** Turn the **MULTI JOG** control or press the **◀/▶** (menu) button on the remote control until "TRACK ERASE" is shown in the information display.

*Please refer to the Glossary for a brief definition of acronyms. (see page 46)

(To be continued on the next page)

4 Press the SET button (main unit/remote control).

- “ERASE (start track) – (last track)?” is flashed in the information display. (Initially, the start track and last track are both the last track number recorded on the CD-RW.)
- Press the CANCEL button (main unit/remote control) if you do not wish to perform this procedure.

5 If needed, use the MULTI JOG control or press the ◀/▶ (menu) button on the remote control to select the number of tracks you want to erase preceding the last track.

- Please note that all tracks following the start track will be erased. For example, when track 8 on an 11 track CD-RW is assigned as the start track, tracks 8, 9, 10, and 11 will be erased.

6 Press the SET button (main unit/remote control).

- “ERASE TRACK” is flashed in the information display, the selected tracks are erased, and the normal display is shown when erasing has been completed.
- Each track that was erased is cleared from the music calendar.
- Tracks can only be erased starting from the last track recorded on a disc.

Notes

- Once a track is erased, the recording cannot be restored.
- Do not turn the power off, disconnect the AC power cord from the wall outlet or subject the unit to vibration during the erase operation. Doing so may ruin the CD-RW disc.

Erasing All Tracks (Disc Erase Function) (CD-RW only)

The Disc Erase function is used to erase the entire contents of the CD-RW. This unit uses a unique high-speed (2x) erasing function that is different from normal erasure procedures. Erasing is performed all the way through the disc's TOC (Table of Contents). “ERASE DISC” flashes in the information display during the erasing process.

*Please refer to the Glossary for a brief definition of acronyms. (see page 46)

Caution

If the disc is damaged or there is disc related trouble, this function may not be possible.

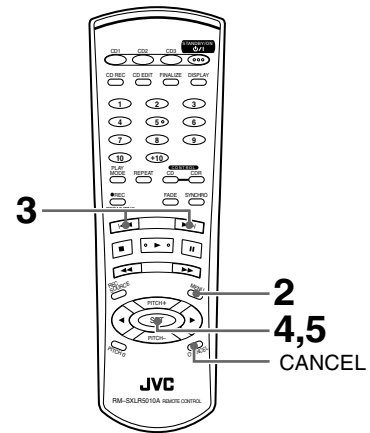
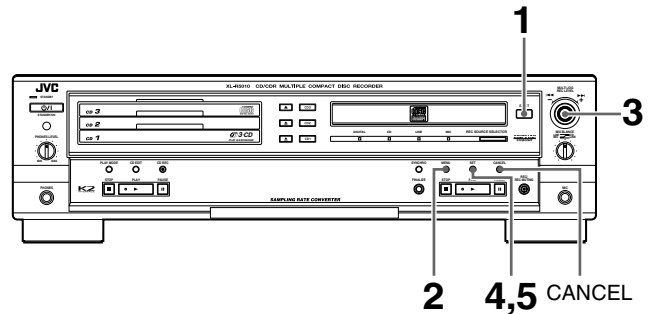

1 Load the CD-RW to be erased in the CDR disc tray.

- The number of tracks and play time are shown in the information display.

2 When the unit is in the stop mode, press the MENU button (main unit/remote control).

3 Turn the MULTI JOG control or press the ◀◀/▶▶ (menu) button on the remote control until “DISC ERASE” is shown in the information display.

4 Press the SET button (main unit/remote control).

- “ERASE DISC?” is shown in the information display.
- Press the CANCEL button (main unit/remote control) if you do not wish to perform this procedure.

5 Press the Set button (main unit/remote control).

- Full disc erasure takes a few minutes to perform. During the procedure, the length of the level meter is used to indicate approximately how much time is remaining until erasure is complete. When the erasure has been completed, the normal display is shown.

Finalizing a Disc

Finalizing a disc marks the final process in recording on a CD-R or CD-RW disc. In this process, a TOC (Table Of Contents) is written to the disc. When this procedure is completed, it will be possible to play the CD-R or CD-RW disc on CD players compatible with CD-R and/or CD-RW discs.

- **Please note that once a CD-R disc has been finalized, it is no longer possible to record to that disc.**
- If the power of the unit is turned off or the AC power cord unplugged from the wall outlet during the finalizing process, the recording may be lost and the disc may no longer be usable.
- Even after a CD-RW disc has been finalized, further recording and/or editing is possible if the TOC information on the disc is erased using the Unfinalize function.
- When an unfinalized CD-R or CD-RW disc is loaded in the CDR and the EJECT ▲ button is pressed to open the CDR disc tray, “FINALIZE?” is shown in the information display. To skip the finalization process, press the EJECT ▲ button one more time or the CANCEL button (main unit/remote control). The disc will be ejected in the unfinalized state.

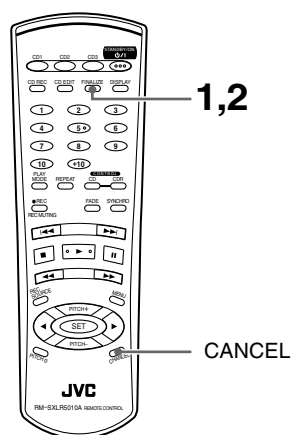
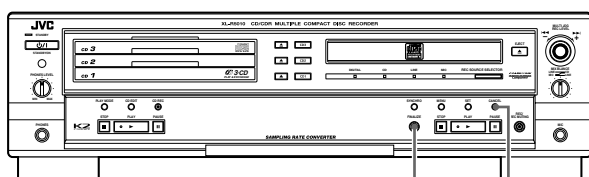

1 Press the FINALIZE button (main unit/remote control).

- “FINALIZE?” is shown in the information display.
- If you want to cancel the finalization process at this point, press the either the EJECT ▲ button or CANCEL button (main unit/remote control).

2 Press the FINALIZE button again to start the finalizing process.

- The length of time that this process requires is about 2 minutes. During the procedure, the length of the level meter is used to indicate approximately how much time is remaining until finalization is complete.
- The 3-CD changer of this unit is compatible with finalized CD-RW discs, however, not all CD players can play back CD-RW disc even after they have been finalized.
- During the finalization process, it will not be possible to remove or load discs in the 3-CD changer, nor is playback of CDs loaded in the 3-CD changer possible.

Making Recording of a Finalized CD-RW Disc Possible (Unfinalize Function)

Once a CD-R disc has been finalized, further recording on that disc cannot be performed. However, if you erase the TOC (Table of Contents) on a CD-RW disc, the disc can be recorded on again.

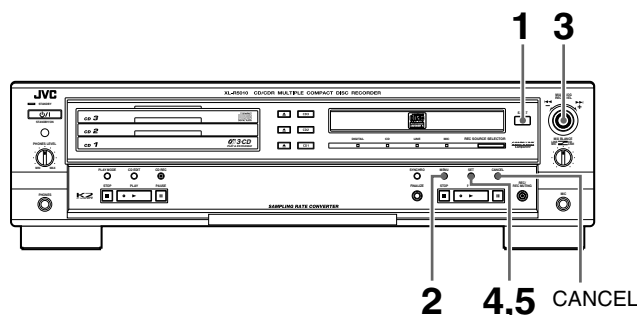

1 Load a finalized CD-RW disc into the CDR disc tray.

- The CD-RW and FINALIZED indicators will be shown in the display window if the CD-RW disc that has been finalized.

2 When the unit is in the stop mode, press the MENU button (main unit/remote control).

3 Turn the MULTI JOG control on the main unit or press the ◀/▶ (menu) button on the remote control until “UNFINALIZE” is shown in the information display.

4 Press the SET button (main unit/remote control).

- “UNFINALIZE?” is shown in the information display.
- Press the CANCEL button (main unit/remote control) to cancel the procedure and return to the normal display.
(To be continued on the next page)

5 Press the SET button again to confirm the operation.

- “UNFINALIZE” is shown in the information display as the unfinalizing procedure is performed. The procedure takes a little over a minute, and the level meter is used to indicate approximately how much time is remaining until unfinalization is complete. Upon completion, the normal display is shown.

Bypassing the FS Converter (Sampling Frequency Converter*) for More Efficient Digital Recording

* known as Sampling Rate Converter.

The FS converter of this unit performs the conversion of digital signals from sources that use sampling frequencies other than 44.1kHz to the sampling frequency of 44.1kHz, which is necessary for recording the signals to a CD-R or CD-RW disc.

- When the FS converter is turned off, the converter is bypassed if the digital signal of the source has a sampling frequency of 44.1kHz and when analog and multiple input recording are performed.
- If source sampling frequencies of 32kHz or 48kHz are detected, the FS converter is activated automatically and the signal is routed through it.
- When the FS converter is turned on, all signals to be recorded are routed through it regardless of the sampling frequency, even the 44.1kHz digital signal is passed through it as the converter works as a filter to reduce signal fluctuation in the disc recording. For this reason, having the function set to “ON” is recommended for most recording purposes.
- When recording specially encoded discs such as dts*¹, HDCD*², etc., be sure to turn the converter off (setting to “OFF”) using the following procedure (see Step 4).

*¹dts is trademark of Digital Theater Systems, Inc.

*²HDCD® is a registered trademark of Pacific Microsonic, Inc.

Note

- When recording from the 3-CD changer, the sampling rate converter is always turned off.

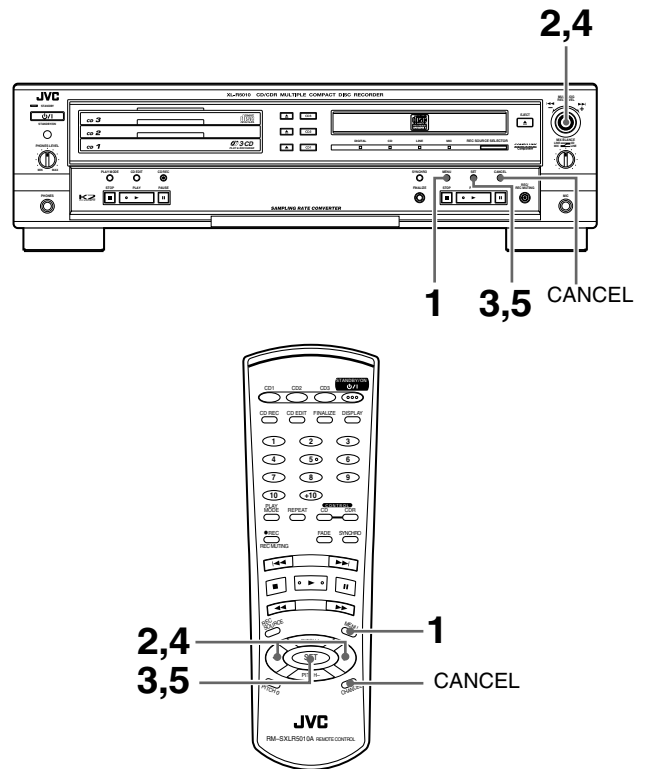

- 1** When the unit is in the stop mode, press the **MENU** button (main unit/remote control).
- 2** Turn the **MULTI JOG** control on the main unit or press the **◀/▶** (menu) button on the remote control until “**CONVERTER**” is shown in the information display.
- 3** Press the **SET** button (main unit/remote control).
 - The “**CONVERTER ON**” is shown and “**ON**” flashes in the information display. (The default setting is “**ON**”.)
 - Press the **CANCEL** button (main unit/remote control) if you do not wish to perform this procedure.
- 4** Turn the **MULTI JOG** control on the main unit or press the **◀/▶** (menu) button on the remote control to select “**ON**” or “**OFF**”.
 - Press the **CANCEL** button (main unit/remote control) if you do not want to perform this procedure. The setting is not changed.
- 5** Press the **SET** button (main unit/remote control).

Notes

- Pressing the **SYNCHRO** button when unlocked displays “**UNLOCK**” in the information window and releases the synchronized condition.

Setting Up Synchronized Start Recording for External Digital Sources (CD, MD, and DAT only)

When performing digital synchronized start recording of an externally connected digital source, synchronized start recording begins when a digital signal is encountered in the record pause mode. However, if the recording source is connected to the DIGITAL IN (DIGITAL IN OPTICAL) terminal, it is also possible to set this unit to start and stop recording when you are recording a single track.

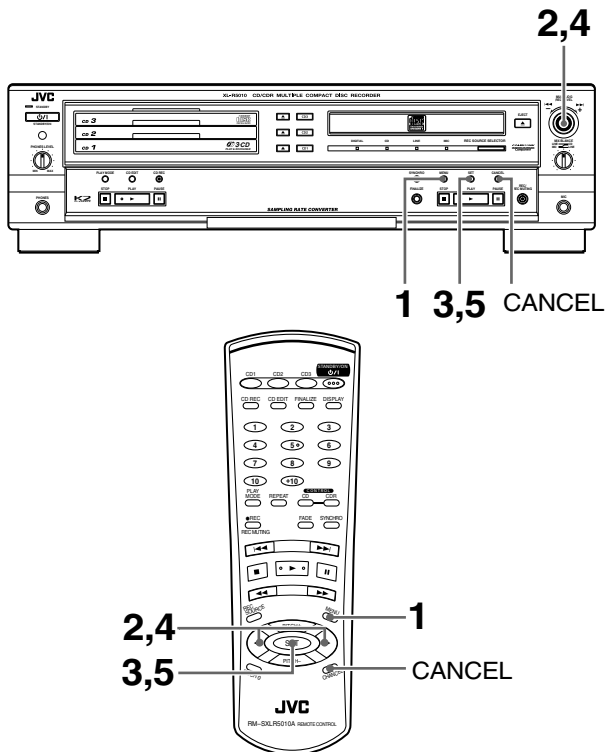

- 1** When the unit is in stop mode, press the MENU button.
- 2** Turn the MULTI JOG on the main unit or press the ◀/▶ button on the remote control until “D-IN SYNCHRO” appears in the display.
- 3** Press the SET button.
 - The current setting appears in the display.
- 4** Turn the MULTI JOG on the main unit or press the ◀/▶ button on the remote control to select “START” or “START&STOP”.
 - When “START” is selected, only the start of the digital signal is recorded synchronously.
 - When “START&STOP” is selected, both the start and stop of single track recording are controlled by information in the source digital signal.
 - Press the CANCEL button if you do not want to perform this procedure. The setting is not changed.
- 5** Press the SET button.
 - Please note that the type of synchronized recording being performed as set in the above procedure is not indicated in the display during actual recording. Even when recording is started, only the “SYNCHRO” indicator remains lit until recording is stopped.
 - Even if this setting is set to “START&STOP”, recording is concluded automatically if the source is stopped, the disc is changed, or if a track search is performed.

Note

- Pressing the SNCHRO button when unlocked displays “UNLOCK” in the information window and releases the synchronized condition.

Resetting the Unit to the Factory Default Settings

By performing the following procedure, all menu settings stored in the unit are cleared and the unit is reset to the factory default settings.

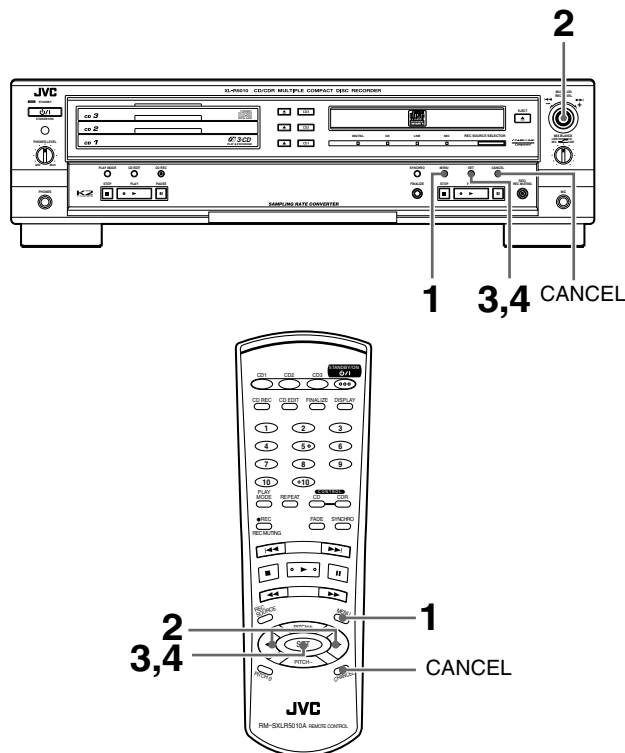

- 1** When the unit is in stop mode, press the MENU button (main unit/remote control).
- 2** Turn the MULTI JOG control on the main unit or press the ◀/▶ (menu) button on the remote control until “SET DEFAULT” is shown in the information display.
- 3** Press the SET button (main unit/remote control).
 - “SET DEFAULT?” is shown in the information display.
 - Press the CANCEL button (main unit/remote control) if you do not want to perform this procedure.
- 4** Press the SET button (main unit/remote control).
 - The unit is reset to the factory default settings and returns to the stop mode.

	At the time of purchase
DUB- SPEED	HIGH (CD- R:4x,CD- RW:2x)
FINALIZE	ON
AUTO TRACK	ON
TRACK SPACE	ON
CONVERTER	ON
D- IN SYNCHRO	START

Setting the Clock

Setting the Present Time

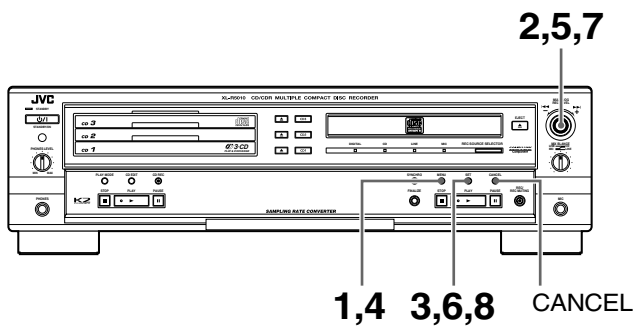

Set the timer immediately after turning on the power to the main unit for the first time. Additionally, should there be a power blackout that lasts for longer than a few seconds, or if the AC power cord of the unit is unplugged from the wall socket for longer than a few seconds, please check to see if the clock needs to be reset again before using any other operation.

- This unit uses a 12-hour clock to indicate time.

If the time has never been set or input time has been canceled due to loss of power (backup failure), etc., "TRACK ERASE" will be shown in the information display when the unit's AC power cord is plugged into a power source. The time can be set regardless of the unit's power switch being turned on or off.

Example

Setting the time to 1:15 PM when first using the system.

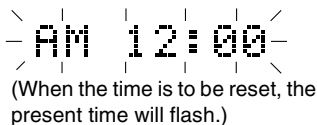

1 Press the MENU button (main unit) while the unit is in the stop mode.

If the time has not been set, the system will go directly to the "XX HH:MM" setting (shown in the information display), bypassing the timer settings. (The only commands that the unit accepts at this time are the MENU, SET and JOG control functions. Pressing of any other button such as CD Control button, CDR Control button or the \odot/I or CANCEL buttons will end the setting mode.)

2 Turn the MULTI JOG to select "CLOCK/TIMER".

3 Press the SET button.

4 Press the MENU button twice.

5 Turn the MULTI JOG control on the main unit the hour column reads "PM 1".

6 Press the SET button (main unit).

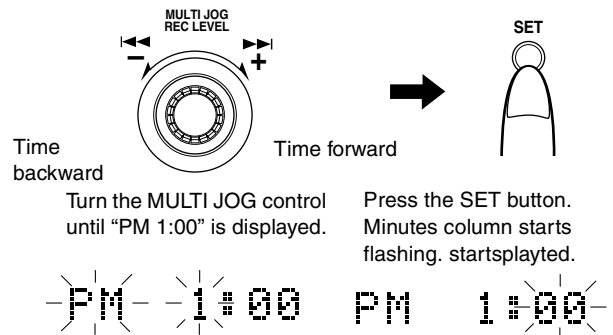

The hour column stops flashing and the minutes column starts flashing.

7 Turn the MULTI JOG control on the main unit until the minutes column reads "15".

8 Press the SET button.

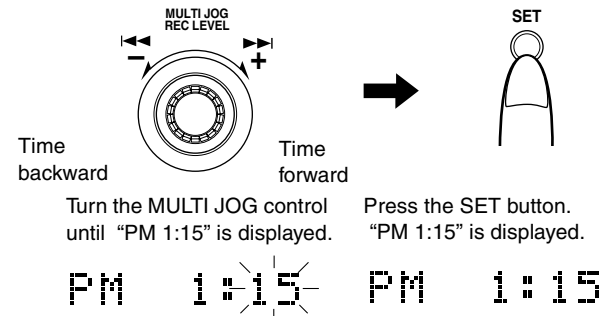

- The current time "PM 1:15" is shown in the information display.
- If the CANCEL button is pressed while setting the minutes column, the procedure returns to the previous step, and the hour column starts flashing. This is convenient for correcting the hour column.

Ways to change or adjust the time display

There are two different ways for accessing the time setting function in order to adjust the time.

1 With the main unit in the standby mode, press the MENU button three times.

- The present time is shown in the information display.

- Follow the instructions for Steps 5-8 above.

2 When the power to the unit is on, press the MENU button one time.

- TRACK ERASE is shown in the information display.
- Using the MULTI JOG Control, change the information display to "CLOCK/TIMER".
- Press the SET button.
- Press the MENU button twice.
- The present time is shown in the information display.
- Follow the instructions for Steps 5-8 above.

- For instructions on how to use the daily timer and one-time timer, please refer to the following pages.

To ascertain the correct time

In most areas, there is a telephone number you can call for the correct time, consult your telephone directory for assistance.

Timer Operations

Timer Play (wake-up play)

Before proceeding with timer programming, make sure that the present time has been set correctly. (see page 38)

- With the exception of the MENU and SET buttons, the timer settings must be made using the controls on the front panel of the main unit.

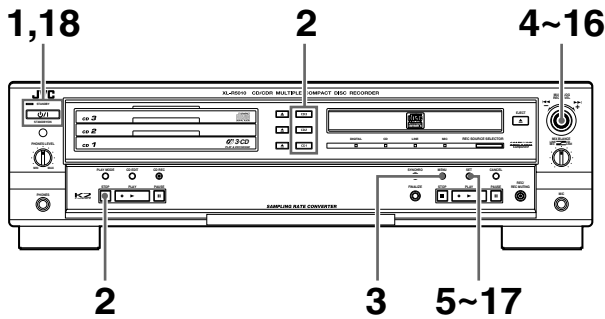

Example: Setting the unit to turn on and play a CD from 7:15 AM to 8:15 AM.

Note

- The setting of the DAILY TIMER (activated every day) and ONCE-TIMER (only conducted once and then erased from memory) is performed following the same instructions after selecting the desired timer function.

- Turn on the power.
- Insert the CD you want to play into the CD1 tray, then press STOP ■ while pressing the CD1 button.

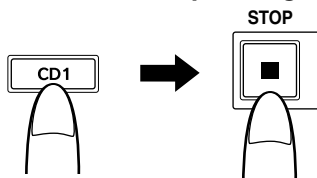

- Press the MENU button.

- "TRACK ERASE" is shown in the information window.
- Turn the MULTI JOG control until "CLOCK/TIMER" is shown in the information display.

- Press the SET button.

- "DAILY TIMER" is shown in the information window.
- To set DAILY TIMER Proceed to step 6.
To set ONCE TIMER Press the MENU button and display "ONCE TIMER", and then proceed to step 6.

- Press the SET button.

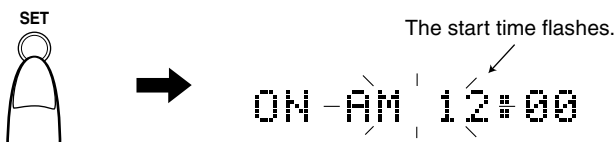

- Turn the MULTI JOG control on the main unit to set the hour column to "AM 7".

- Press the SET button.

* The hour column stops flashing and the minute column starts flashing.

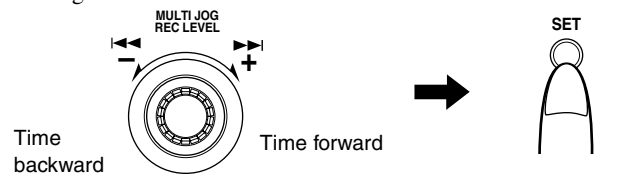

- Turn the MULTI JOG control until "AM 7:00" is displayed.
- Press the SET button. "AM 7:00" is displayed.



- Turn the MULTI JOG control on the main unit to set the minutes column to "15".

- Press the SET button.

- The off time of the timer is shown and the hour column flashes.

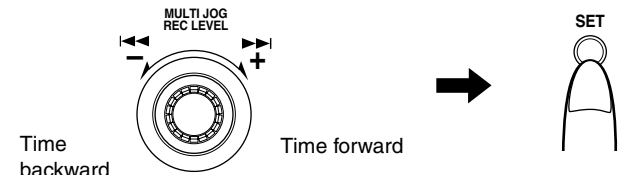

- Turn the MULTI JOG control until "AM 7:15" is displayed.
- Press the SET button. "OFF AM 12:00" is displayed.

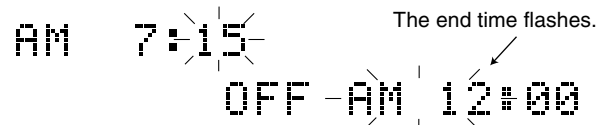

- Turn the MULTI JOG control on the main unit to set the hour column to "AM 8".

- Press the SET button.

- The hour column stops flashing and the minutes column flashes.

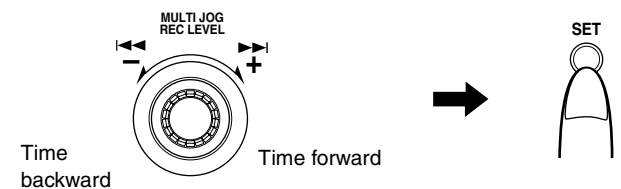

- Turn the MULTI JOG control until "AM 8:00" is displayed.
- Press the SET button. "AM 8:00" is displayed.



- Turn the MULTI JOG control on the main unit to set the minutes column to "15".

14 Press the SET button.

- “PLAY” is displayed.

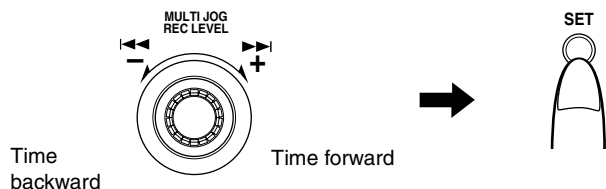

7. Turn the MULTI JOG control until “AM 8:15” is displayed.
8. Press the SET button. “PLAY” is displayed.

AM 8:15 -PLAY-

- If “REC” flashes rather than “PLAY”, turn the MULT JOG control until “PLAY” is shown flashing.

Note

- If the CANCEL button is pressed while setting the minutes column, the procedure returns to the previous step, and the hour column starts flashing. This is convenient for correcting the hour column.

15 While “PLAY” is flashing, press the SET button.

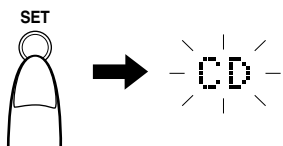

16 Turn the MULTI JOG control on the main unit to set the function to CD or CDR.

17 Press the SET button.

- The Daily Timer “DAILY” indicator is shown in the display window confirming that the play mode is set.
- When setting the ONCE TIMER, the “ONCE” indicator is shown in the display window confirming that the play mode is set.

Example: DAILY TIMER

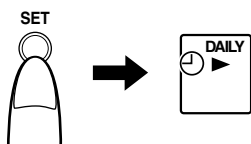

The timer programming is displayed once, and then the normal display is restored.

- If “REC” should flash rather than “PLAY”, turn the MULTI JOG control on the main unit until “PLAY” is shown flashing.

18 Set the power to standby mode.

Notes

- Timer functions cannot be performed if the unit is on when the set time arrives. Make sure that the unit is put in standby for timer functions to operate.
- Match the connected receiver or other source with the unit’s setting, and adjust the volume to the appropriate level. Match the timer with the unit’s setting.
- Timer play starts at the programmed start time, and the power is switched to the standby mode at the programmed end time.

Clearing a timer operation From Standby Mode

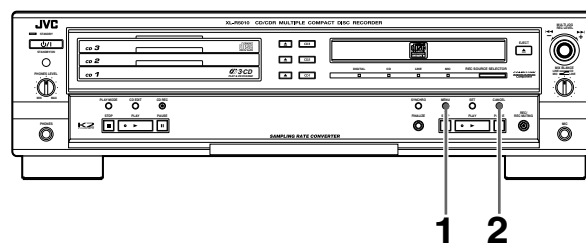

1 Press the MENU button to display “DAILY TIMER” or “ONCE TIMER”.

2 Press the CANCEL button (main unit/ remote control).

- “DAILY OFF” or “ONCE OFF” is shown in the information display, the DAILY ► (or ONCE ►) indicator is cleared from the display window, and the timer operation is canceled.

With Unit Power Turned On

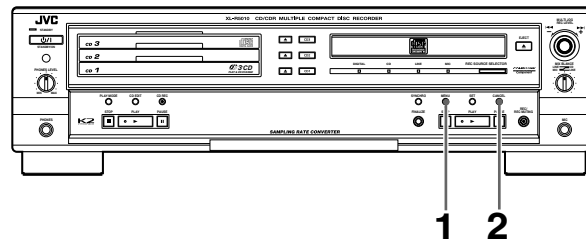

1 Follow steps 1 through 5 in "Timer Play (wake-up play)" to display "DAILY TIMER" or "ONCE TIMER".

2 Press the CANCEL button.

- “DAILY OFF” or “ONCE OFF” is shown in the information display the DAILY ► (or ONCE ►) indicator is cleared from the display window, and the timer operation is canceled.

Timer Recording (Unattended Recording from a Broadcast Receiver or Other Source)

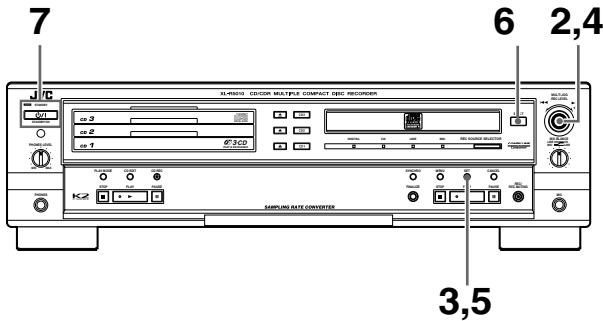

- 1** Perform steps 1 to 13 of the Timer Play (wake-up play) procedure. (see page 40)
- 2** When “PLAY” is flashing in the information display, turn the MULTI JOG control on the main unit to select “REC”.
- 3** Press the SET button.

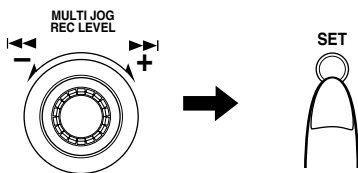

- 4** Turn the MULTI JOG control on the main unit to select the source to be recorded from.
- 5** Press the SET button.

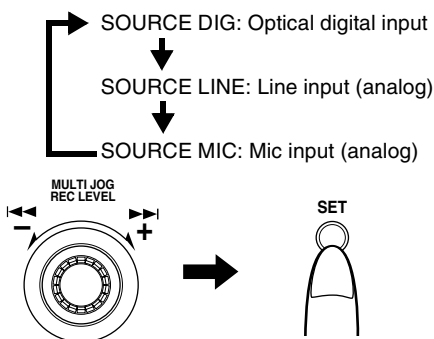

- 6** Load a recordable CD-R or CD-RW disc into the CDR.

- The disc is read.

- 7** Set the power to standby mode.

- The present time is shown in the information display.

Notes

- Match the timer of the connected source with the unit's setting. (In the case of MIC input, ensure that the microphone has been connected to the unit.)
- Recording starts at the programmed start time, and the power will be switched to back to the standby mode at the programmed end time.
- When an operation is completed once using the Once Timer mode, the timer program is cleared.
- If digital signals are not received when timed recording starts using the DIGITAL IN setting, “UNLOCK” is shown in the information display and no signals will be recorded.
- When using the timer to record a digital satellite broadcast program, for instance, check to see if the broadcast station with the program you want to record is tuned in correctly before programming the timer start and end times.

COMPU LINK Function

What is COMPU LINK?

The COMPU LINK Remote Control System (or, simply, "COMPU LINK") serves to enable the kind of simple operations provided by an integrated system to be performed even though this unit is a separate component.

These simple operations can be performed by connecting the COMPU LINK-4 SYNCHRO, COMPU LINK-3 SYNCHRO or COMPU LINK-1 SYNCHRO connector on each of the components involved.

Connections

Accessory connecting cables

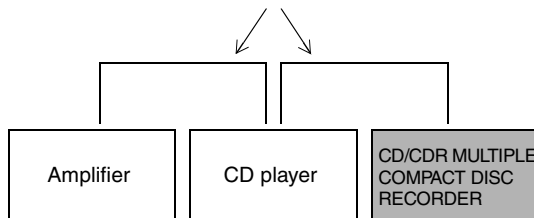

The COMPU LINK functions provided with JVC products come in the form of COMPU LINK-4, COMPU LINK-3 or COMPU LINK-1. They are compatible, and the difference between them is that COMPU LINK-3 has the functions of COMPU LINK-1 with some additional functions as well.

COMPU LINK functions compatible with this unit

Automatic Power On/Standby

Selecting a source on the amplifier/receiver automatically turns on the relevant component. Similarly, turning a linked component on automatically turns the amplifier/receiver on.

Automatic Source Selection

Selecting a source on the connected amplifier/receiver automatically starts its operation. Similarly, starting operation of a linked component will automatically select the relevant source on the amplifier/receiver.

When this unit is selected as the source, a selected tray (3CD or CDR) will start to play

Notes

- The type of interactive operation described above requires that your JVC amplifier/receiver feature COMPU LINK-4, or it will not be compatible with this unit (the CDR will not be recognized by previous COMPU LINK versions). When your JVC amplifier/receiver does not feature COMPU LINK-4, set the COMPU LINK MODE switch on the rear panel of this unit to "TD", and make connections to the tape deck connectors on the amplifier/receiver. Doing this enables you to use this unit with the COMPU LINK functions, however, COMPU LINK control of a cassette deck will no longer be possible.
- Synchro recording using the COMPU LINK is not compatible with this unit.

CD and CDR Messages

Note: Items with () marks are confirmation displays

CD Messages

Message	Significance	Remedy
CD * NO DISC (* indicates the disc tray number)	There is no disc in the selected tray.	If no disc has been inserted, insert a CD-ROM (CD-DA formatted) or a CD-R or CD-RW disc.
CD * DISC NG (* indicates the disc tray number)	Disc related trouble has occurred and the disc in the selected tray cannot be played.	Replace the disc.
ALL SKIP TR	All the tracks on the disc have TRACK SKIP markers. (Depending on the playback function, playback may proceed to the next disc without displaying anything.)	Replace the disc with one that contains tracks that can be played.
CANNOT PLAY	Displayed when a CD for which all of its tracks are marked to be skipped is loaded into the 3-CD changer and the PLAY button pushed.	

CDR Messages

Message	Significance	Remedy
OPC ERROR	OPC adjustments cannot be done to comply with the disc loaded in the CDR. When this occurs, record and erase functions are not possible. (Playback is possible.)	Replace the disc with a CD-R or CD-RW that can be recorded on.
OPC FULL	Although time remains on the disc, the PCA (Power Calibration Area) is full, preventing further recording and erasing (playback is possible). Recording is possible if the disc has been recorded to by another unit and the adjustment information has been maintained.	Replace the disc with a CD-R or CD-RW that can be recorded on.
CDR NO DISC	A CD, CD-R or CD-RW has not been inserted.	Insert a CD, CD-R or CD-RW.
BLANK DISC	A CD-R or CD-RW with nothing recorded on it has been inserted. Playback and erase functions are not possible.	
CDR DISC NG	Disc related trouble has occurred and the disc in the tray cannot be played or recorded on.	Replace the disc.
PMA FULL	Although time remains on the disc, the PMA area is full, preventing further recording. PMA is an abbreviation of Program Memory Area.	Replace the disc with a CD-R or CD-RW that can be recorded on. Finalization of the disc is recommended.
NO R/RW DISC	A CD-R or CD-RW disc has not been inserted.	Insert a CD-R or CD-RW.
ALREADY FINAL	The disc loaded in the CDR is a finalized CD-R or CD-RW	When using a CD-RW, perform the Unfinalize function to allow further recording.
NO AUDIO DISC	The disc inserted is not for music.	Replace with a disc intended for music.
ALL SKIP TR	All the tracks on the disc have TRACK SKIP markers. (Depending on the playback function, playback may proceed to the next disc without displaying anything.)	Replace the disc with one that contains tracks that can be played.

Message	Significance	Remedy
NO R/RW DISC	The disc inserted is a CD for computer data. Recording and erase functions are not possible.	Check to see if the CD-ROM is recorded in audio format. If not, replace with a disc recorded using the CD-DA format.
DISC FULL	The CD-R or CD-RW has no available time.	Replace with another recordable CD-R or CD-RW. Finalization of the disc is recommended.
TNO FULL	99 tracks have been recorded on the disc. Further recording is not possible.	Finalize the disc. Replace the disc to perform further recording.
CANNOT REC	Recording is not possible. This may be caused by poor connections or disc trouble.	Check connections and/or replace the disc.
UNLOCK	When performing digital recording of an external component, the digital signal from the component is not being sent or the signal being sent cannot be recorded by this unit.	Check the connection between the component and this unit and confirm that the digital signal being output from the component is compatible with this unit.
SCMS PROTECT	In accordance with SCMS regulations, digital recording cannot be performed.	Switch the source selection to select input from the analog connections, and perform analog recording.
NOT AUDIO IN	The digital signal is not an audio format.	Set the source component to output a digital audio signal. For example, if a data track on a CD is selected, switch to a track that contains audio data.
NOT REC MUTE	The ● REC/REC MUTING button has been pressed at a time when the function cannot be performed.	See page 22 for information on when the muting function can be used, and press the ● REC/REC MUTING button when the function can be performed.
SHORT REMAIN	Not enough time remains on the disc to continue synchronized recording from the 3-CD changer to the CDR.	Replace the disc with a disc that contains sufficient recording time.
CANNOT FIN	Trouble with the CD-RW has prevented finalization from being performed.	Replace the disc
NO RW DISC	A CD-RW has not been inserted. Erase and Unfinalize functions are not possible.	
CANNOT ERASE	Trouble with the CD-RW has prevented an erase function from being performed.	Replace the disc
CANNOT UNFIN	Trouble with the CD-RW has prevented the Unfinalize function from being performed.	Replace the disc
DAO DISC	The Unfinalize function cannot be performed with discs recorded using the "DISC at Once" recording system.	
SKIP FULL	The maximum number of 21 tracks on the disc that can be skipped has been reached. Skip marking more than 21 tracks is not possible with this unit.	

SCMS (Serial Copy Management System)

The digital quality of CDs and other digital media can be recorded to CD-R and CD-RW using the CDR function of this unit. However, it is not possible to make a second generation digital copy from a first generation copy. This restriction, known as SCMS (Serial Copy Management System), is intended to prevent unlimited digital copying in the interests of artists and other copyright holders.

This unit is designed to comply with SCMS restrictions.

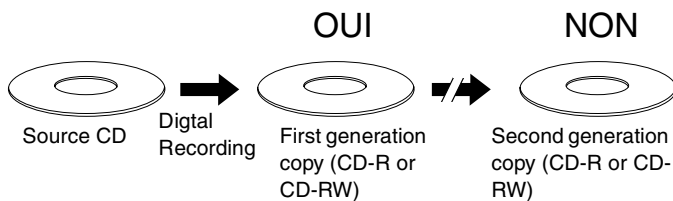

The copyright laws allow recordings to be made for the personal enjoyment of the individual user but they do not allow such recordings to be used for any other purpose without permission from the rightful owner of the copyrights.

Note

- If digital recording of a first generation digital copy is attempted, "SCMS PROTECT" is shown in the information display, and the recording operation is canceled.
- In the case of synchronized recording operations, Listening Edit recording and Program Edit recording, when the first-generation copy is a finalized CD-R or CD-RW disc loaded in the 3-CD changer, the recording type is automatically changed from digital to analog, and the recording type indicators light accordingly. (If high-speed dubbing is turned on, it will be turned off when the recording type is changed.)

Glossary

The following is a brief description of some of the acronyms used in this manual.

ATIP (Absolute Time in Pregroove)

The reflected light returned from the pregroove of a CD-R disc generates a carrier signal providing tracking, motor control and focus signals. Additional information including the Recommended Optimum Recording Power value is also encoded in a frequency modulation of the carrier signal.

CD-R (Compact Disc-Recordable)

The reference to recordable disc media. Also often referred to as write-once discs as data can only be recorded one time.

CD-RW (Compact Disc-ReWritable)

Recordable disc media to which data can be recorded and erased repeatedly.

OPC (Optimized Power Control)

Analysis of recordable CD media to determine the optimum power setting for recording of data to the disc.

PCA (Power Calibration Area)

A space reserved at the beginning of a disc for calibrating the laser power needed to record that disc.

PMA (Program Memory Area)

On a recordable disc, it is the area that "temporarily" holds the information about the recordings on the disc: the track numbers and the track starting and stopping points when written in a session that is not yet closed (unfinalized disc). When the session is closed (the disc is finalized), this information is written to the TOC.

TOC (Table of Contents)

The area on a CD to which is recorded various information of the disc contents such as the number of tracks, their starting points, and the total length of the data area.

	Symptom	Cause	Remedial action/check	Ref
COMMON	No sound.	<ul style="list-style-type: none"> A CD-R or CD-RW with nothing recorded on it has been inserted. ("BLANK DISC" is displayed.) 	<ul style="list-style-type: none"> Replace the disc with one on which tracks have been recorded. 	
	The time display flashes in the display window.	<ul style="list-style-type: none"> A power failure has occurred or the power cord has been disconnected. 	<ul style="list-style-type: none"> Set the clock and re-program the timer. 	38
CD PLAYER	Play fails to start	<ul style="list-style-type: none"> The CD has been inserted upside down. 	<ul style="list-style-type: none"> Insert it properly with the label side facing up. 	11
		<ul style="list-style-type: none"> Condensation has formed on the lens. 	<ul style="list-style-type: none"> Turn on the power and wait for a couple of hours. 	2
	Specific parts are not played properly.	<ul style="list-style-type: none"> The CD is scratched. 	<ul style="list-style-type: none"> Replace the CD. 	11
CDR	Recording is not possible	<ul style="list-style-type: none"> The CD-R or CD-RW was loaded in the tray upside-down. 	<ul style="list-style-type: none"> Load the disc with the label side up. 	12
		<ul style="list-style-type: none"> The CD-R or CD-RW is already finalized. Further recording on a finalized CD-RW is only possible if the Unfinalize function is used. 	<ul style="list-style-type: none"> Replace with a disc that can be recorded on. 	35
		<ul style="list-style-type: none"> The source being copied is already a digital copy itself. 	<ul style="list-style-type: none"> Perform analog recording of the source. 	21
		<ul style="list-style-type: none"> There is dust or scratches on the surface of the disc. 	<ul style="list-style-type: none"> Clean the disc using a commercially available disc cleaner. If this is not effective, replace the disc. 	20
TIMER	Timer fails to start.	<ul style="list-style-type: none"> Present time is not correct. The timer display fails to appear. 	<ul style="list-style-type: none"> Set the time properly. Set the timer properly. 	38
REMOTE CONTROL	No remote control operations.	<ul style="list-style-type: none"> The dry batteries in the remote control have discharged. 	<ul style="list-style-type: none"> Replace them with two fresh batteries (AA (15F), R6, SUM-3). 	9
		<ul style="list-style-type: none"> The remote control sensor is exposed to direct sunlight or some other intense source of light. 	<ul style="list-style-type: none"> Move the unit so that the sensor is not exposed to direct sunlight, a lighting fixture or some other intense source of light. 	9

If the unit fails to operate properly even when the remedial action suggested above has been taken:

This unit uses a microcomputer to perform a large number of operations. If it fails to operate no matter which button is pressed, disconnect the power cord, and then wait a few moments before re-connecting it. Then set the time and re-program the timer.

Notes

- If something important is going to be recorded, always test-record first to check that the recording turns out properly before proceeding with the actual recording.
- The manufacturer assumes no liability whatsoever for any damages resulting from missed opportunities or accidental erasure that occurs while conducting recording or play operations due to malfunctioning of or trouble in the unit, or for any incidental damage.

Main Specifications

The unit's specifications and exterior are subject to change without notice due to improvements.

CD Player Section

System	Compact disc digital audio system
Pitch control	±12%
Signal-to-noise ratio	97dB
Dynamic range (1 kHz)	93dB
Frequency response	20 - 20kHz
Wow and flutter	Less than measurable limit
Total harmonic distortion	0.0063%

CDR Section

System	Compact disc digital audio recording system
Sampling frequency	44.1kHz
Frequency response	20 - 20kHz
Inputs: Analog (LINE IN)	Minimum input level: 300mV (Full scale -12dB)/50kΩ
Digital (optical)	Input level: -23dBm - -15dBm (With sampling rates 32kHz, 44.1kHz, 48kHz)
Microphone	Minimum input level: 3mV (Full scale -12dB)/600Ω - 10kΩ matching impedance
Signal-to-noise ratio	94dB (during playback)
Dynamic range (1 kHz)	91dB (during playback)
Wow and flutter	Less than measurable limit
Total harmonic distortion	0.0063% (during playback)

Timer Section

Timer system	DAILY TIMER operation (ON/OFF timer) ONCE TIMER operation (ON/OFF timer)
Clock display	12-hour display

Common Specifications

Output terminals:	
Analog	LINE x 1 set, 2V/5kΩ (Full scale) Headphones x 1, 4mW/32Ω 8Ω ~ 1kΩ matching impedance
Digital	OPTICAL x 1, -21dBm - -15 dBm COAXIAL x 1
Other terminals	COMPU LINK-4/SYNCHRO x 2
Power requirements	120V  , 60Hz
Power consumption	40W power ON mode 5W STANDBY mode
Dimensions (W x H x D)	435mm x 127mm x 334mm (17-3/16in. x 5in. x 13-3/16in.)
Mass	Approx. 6.3kg (13.9lbs)

Accessories

Remote control	RM-SXLR5010A x 1
Batteries	AA (15F), R6, SUM-3 dry batteries x 2 (to check operation of remote control)
Pin cables	x 2
COMPU LINK-4 cable	x 1